

# 2385A

## FLAT-FRONT BI-RADIAL™ HORN



### FEATURES:

Uniform horizontal on and off axis frequency response

Precise horizontal and vertical pattern control

Full horn loading to 500 Hz

Flat front and compact size

Lightweight construction

49 mm (2 in) throat entry

The JBL 2385A Bi-Radial™ horn<sup>1</sup> is designed for flush cabinet mounting or compact cluster applications. The 2385A has a nominal 60° horizontal x 40° vertical pattern. The horn provides uniform on and off axis frequency response from 500 Hz to beyond 16 kHz in the horizontal plane and 2 kHz to 16 kHz in the vertical plane with constant directivity above 2 kHz. The horn's small vertical mouth dimension (just slightly larger than the compression driver used to drive the horn) allows very compact single and multiple horn/driver systems to be put together. Should vertical pattern control be required below 2 kHz, two or more horns may be stacked vertically to restore full Bi-Radial™ performance.

The exceptionally consistent horizontal dispersion eliminates the midrange narrowing and high frequency beaming problems typically associated with conventional horn designs. Additionally, the highly predictable performance of the 2385A greatly simplifies cluster design. The need for horn overlapping is minimized and lobing and comb filter effects are virtually eliminated.

Computer-aided design techniques were used to derive the horn contours in the horizontal and vertical planes. Utilizing sidewall contours based on a polynomial power series formula, the horn design yields smooth response, low distortion, and

even coverage. This design avoids the performance disadvantage of horns that feature sharp flare transitions and flat sidewalls. The Bi-Radial™ compound flare configuration provides constant coverage over defined, solid angles. To ensure light weight, superior strength, and freedom from resonances, the horn bell is constructed of molded structural foam.

The 2385A will accept the 49 mm (2 in) diameter throat 2446, 2450, or 2485 compression driver. With the addition of the 2327 adapter, the horn will also accept the 25 mm (1 in) throat 2426 driver.

US Patent No 4,308,932 Foreign patents pending

## SPECIFICATIONS:

Throw:	Medium	Construction:	Molded structural foam (nominal 10 mm [0.38 in] wall thickness)
Horizontal Coverage:		Overall Dimensions:	
Angle Degrees (-6 dB):	70 (+20, -15)	Mouth Height:	279 mm [11 in]
Average Range:	500 Hz - 16 kHz	Mouth Width:	445 mm [17.5 in]
Vertical Coverage:		Length:	236 mm [9.28 in]
Angle Degrees (-6 dB):	40 (+11, -11)	Mounting Dimensions:	
Average Range:	2 kHz - 16 kHz	Rear Height:	235 mm [9.25 in]
Directivity Factor (Q):	19.0 (+6, -7)	Rear Width:	400 mm [15.75 in]
Directivity Index (Di):	12.8 dB (+2.0, -2.0)	Baffle Cutout Required:	[Front mounting only]
Average Range:	1 kHz - 16 kHz	Height:	238 mm [9.38 in]
Usable Low-Frequency Limit:	400 Hz	Width:	403 mm [15.78 in]
Minimum Recommended Crossover Frequency:	500 Hz	Net Weight:	2.2 kg [6 lb]
Axial Pressure Sensitivity <sup>1</sup> :	114 dB SPL 1 W @ 1 m	Shipping Weight:	4.6 kg [10 lb]

Measured on axis in the far field with 1 watt input (4.0 volts RMS, 16 ohms) and referenced to 1 meter distance using the inverse square law. Listed sound pressures (SPL re 20 µPa) represent an average from 1 kHz to 4 kHz using the 2446, 2450 or 2485 driver

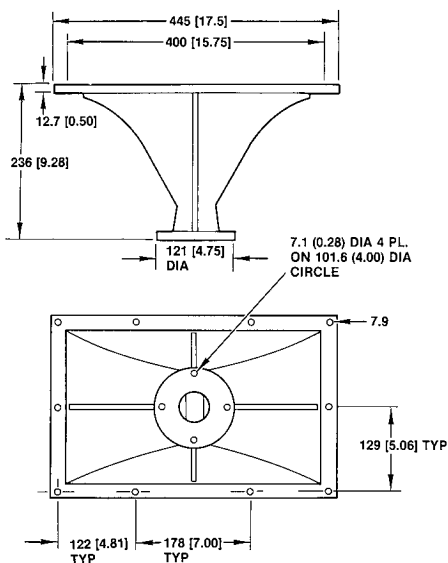

### Beamwidth vs Frequency

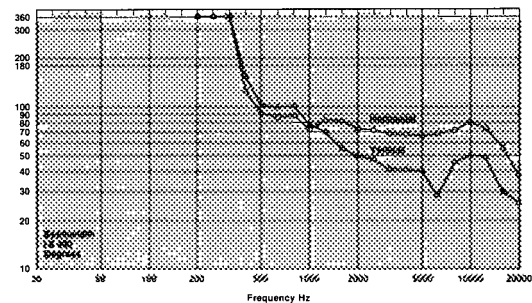

### Directivity vs Frequency

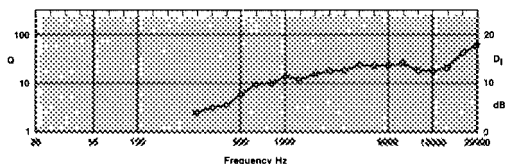

Frontal Isobar Contours

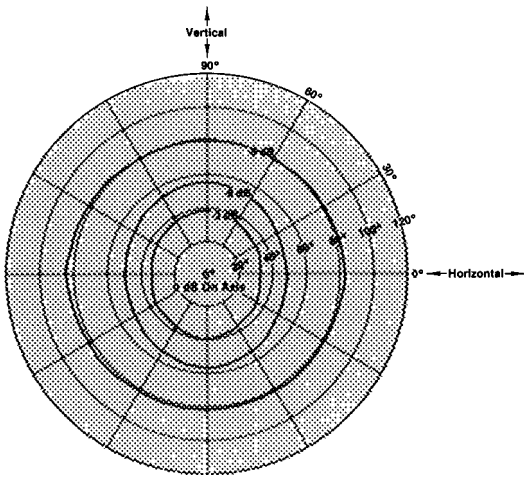

500 Hz octave bandwidth constant sound pressure contours of 0 to -15 dB in steps of -3 dB. The contours are plotted on polar grid lines with on axis being the center of the plot. The data was gathered by taking an octave polar plot at all oblique angles from 0° (horizontal) to 90° (vertical) in steps of 15°. Same test conditions as horizontal polar response.

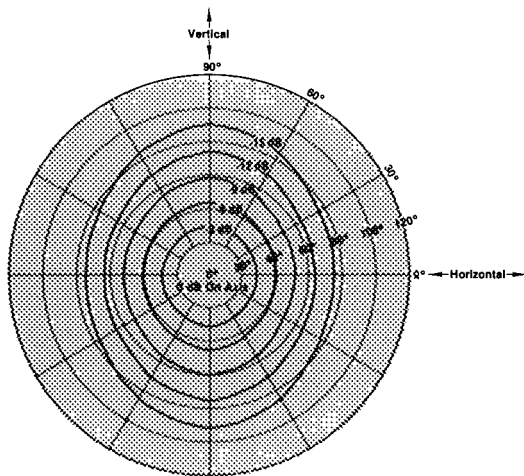

1 kHz octave bandwidth constant sound pressure contours. Same conditions as 500 Hz contours.

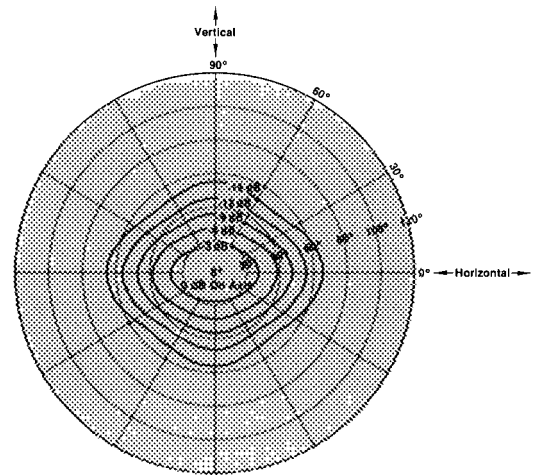

2 kHz octave bandwidth constant sound pressure contours. Same conditions as 500 Hz contours.

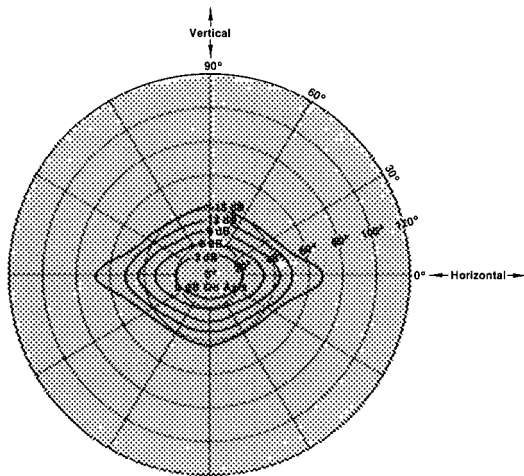

4 kHz octave bandwidth constant sound pressure contours. Same conditions as 500 Hz contours.

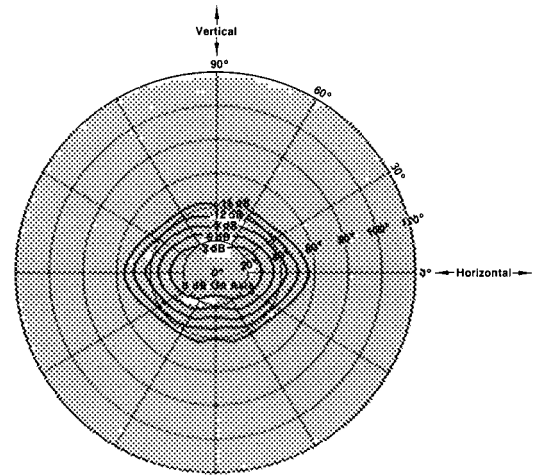

8 kHz octave bandwidth constant sound pressure contours. Same conditions as 500 Hz contours.

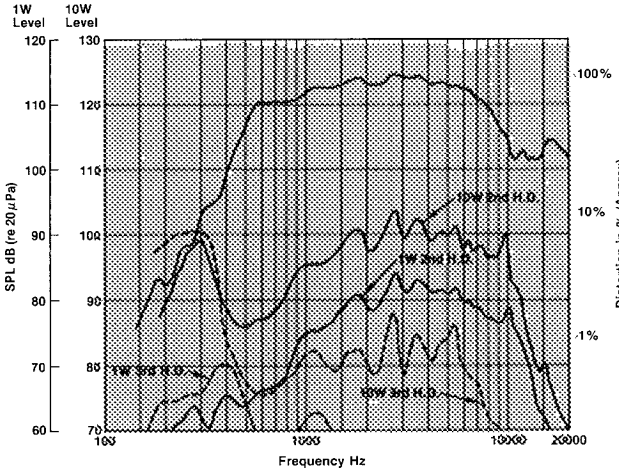

Harmonic distortion. Second and third harmonic distortion curves of the 2385A with 1 watt (4.0 V RMS) and 10 watts (12.65 V RMS) applied to the JBL Model 2445 compression driver. Measured on axis at a distance of 1 meter in a reflection-free environment.

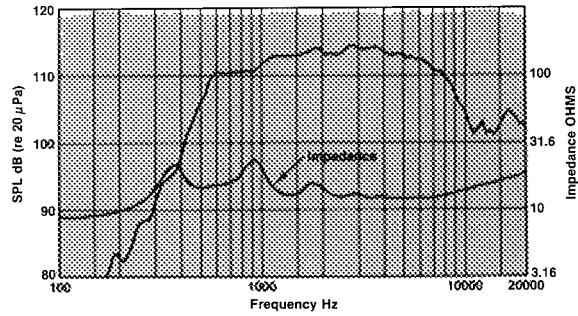

Frequency response and impedance. Frequency response of the 2385A, measured on axis at a distance of 1 meter with 1 watt (4.0 V RMS) applied to a JBL Model 2445 compression driver, in a reflection-free environment, with impedance vs. frequency curve.

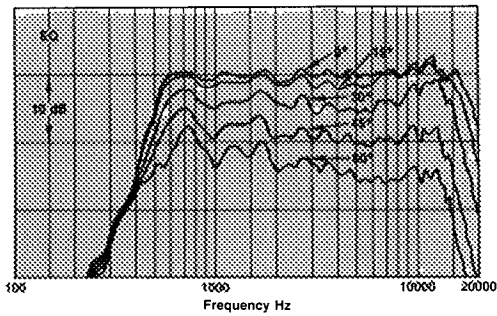

Horizontal off-axis response. Horizontal off-axis response taken at 15 degree intervals out to 60° off axis. Both normalized (equalized flat on axis) and unequalized responses are shown.

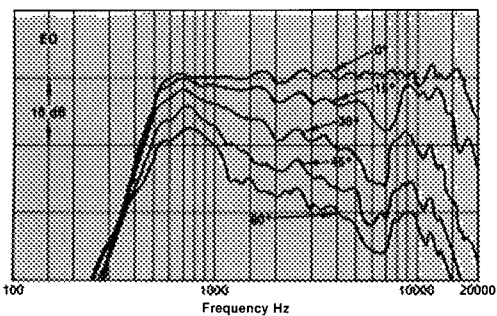
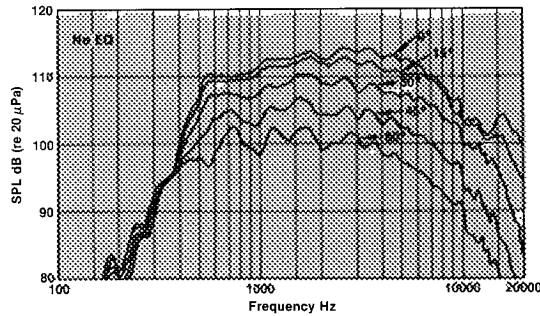

Vertical off-axis response. Vertical off-axis response taken at 15° intervals out to 60° off axis. Both normalized (equalized flat on axis) and unequalized responses are shown.

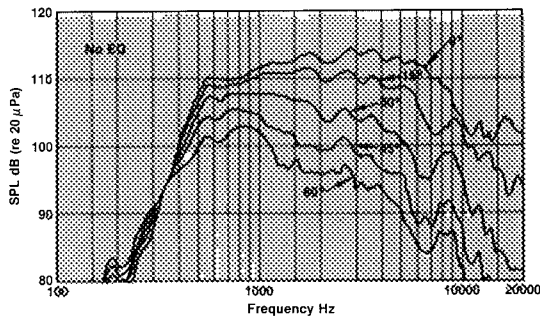

JBL continually engages in research related to product improvement. New materials, production methods, and design refinements are introduced into existing products without notice as a routine expression of that philosophy. For this reason, any current JBL product may differ in some respect from its published description, but will always equal or exceed the original design specifications unless otherwise stated.

