

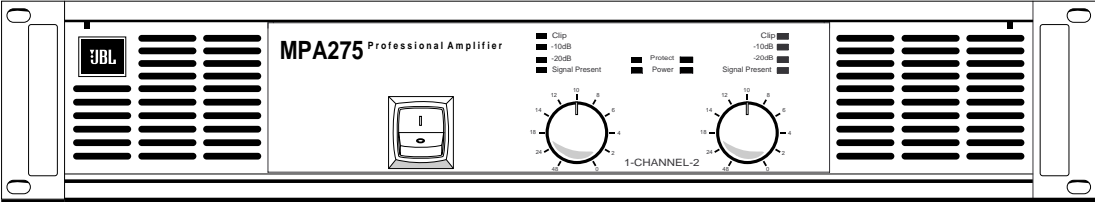

# MPA Series Power Amplifiers

## Owner's Manual



MPA275

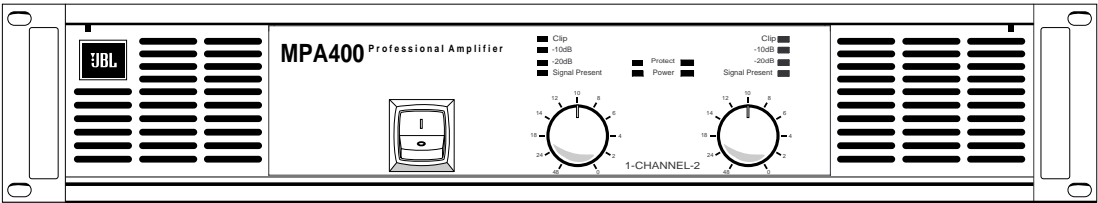

MPA400

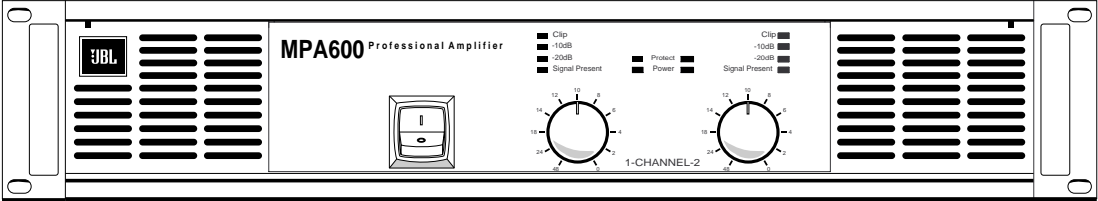

MPA600

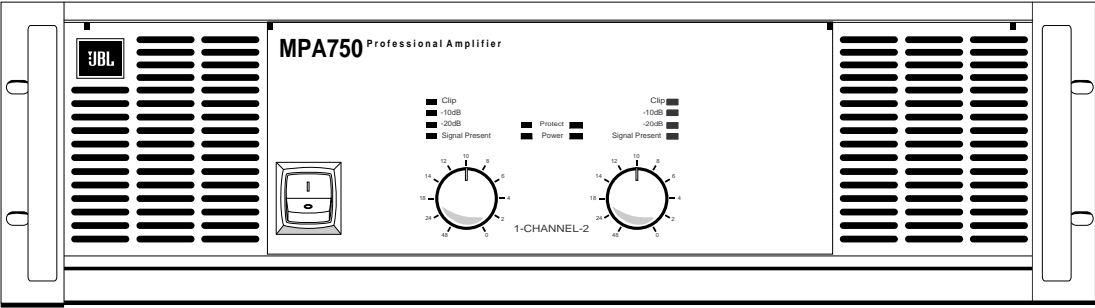

MPA750

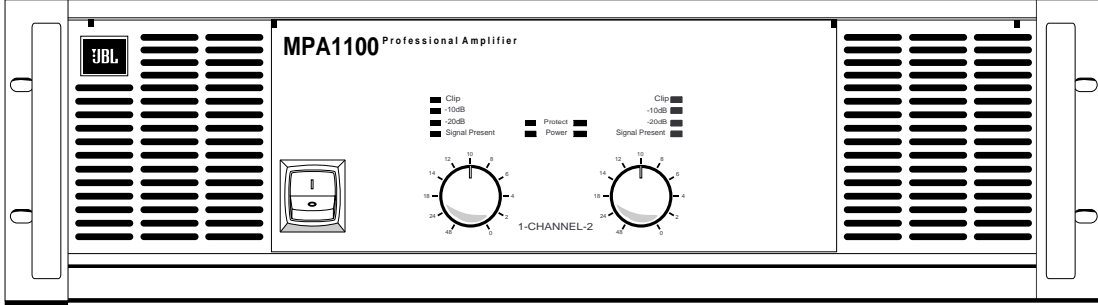

MPA1100

# Cautions

## Rack Mounting Precautions

To avoid damage to the amplifier mounting ears and/or rack rails, the amplifier must be supported at all four corners when used in portable racks.

Consult JBL Service Dept for availability of Rear Support Brackets.

## Lifting Precautions

In order to safely move or install the amplifier, it is recommended that two persons share the weight when lifting and positioning the unit.

**CAUTION**  
TO AVOID ELECTRIC SHOCK, DO NOT INSERT FINGERS OR OBJECTS INTO ANY OPENINGS IN THE CABINET.

# Sicherheitsvorschriften

## Sicherheitsvorschriften für den Einbau in ein Gestell

Um Schäden auf den Befestigungsleisten des Verstärkers und/oder den Gestellschienen zu vermeiden, muß der Verstärker beim Einbau in ein tragbares Gestell an allen vier Ecken gestützt werden.

Erkundigen Sie sich bei der JBL-Kundendienstabteilung nach Stützen für die Rückseite des Verstärkers.

## Sicherheitsvorschriften beim Hochheben

Um den Verstärker sicher zu verschieben oder einzubauen, wird empfohlen, das Gewicht des Verstärkers beim Hochheben und Verschieben gleichmäßig auf zwei Personen zu verteilen.

**VORSICHT**  
UM ELEKTRISCHEN SCHLAG ZU VERMEIDEN, KEINE FINGERN ODER GEGENSTÄNDE IN ÖFFNUNGEN DES GEHÄUSES STECKEN.

**WARNING: TO PREVENT FIRE OR ELECTRIC SHOCK, DO NOT EXPOSE THIS EQUIPMENT TO RAIN OR MOISTURE.**

**WARNUNG: ZUR VERMEIDUNG VON FEUER ODER ELEKTRISCHEN SCHLÄGEN DAS GERÄT NICHT MIT REGEN ODER FEUCHTIGKEIT IN BERÜHRUNG BRINGEN.**

**Explanation of Graphical Symbols**  
The lightning flash with arrowhead symbol, within an equilateral triangle, is intended to alert the user to the presence of uninsulated "dangerous voltage" within the product's enclosure that may be of sufficient magnitude to constitute a risk of electric shock to humans.  
The exclamation point within an equilateral triangle is intended to alert the users to the presence of important operating and maintenance (servicing) instructions in the literature accompanying the product.

**Erklärung der graphischen Symbole**  
Der Blitz mit nach unten zeigendem Pfeil in einem gleichseitigen Dreieck weist den Benutzer auf das Vorhandensein einer unisolierten, "gefährlichen Spannung" im Gehäuse hin, die stark genug sein kann, einer Person einen elektrischen Schlag zu versetzen.  
Das Ausrufezeichen in einem gleichseitigen Dreieck weist den Benutzer auf wichtige Betriebs- und Wartungsvorschriften in den Beiliegenden Unterlagen des Gerätes hin.

**CAUTION**  
RISK OF ELECTRIC SHOCK  
DO NOT OPEN

**CAUTION: TO REDUCE THE RISK OF ELECTRIC SHOCK, DO NOT REMOVE THE COVER. NO USER-SERVICEABLE PARTS INSIDE. REFER SERVICING TO QUALIFIED SERVICE PERSONNEL.**

**VORSICHT**  
GEFAHR EINES ELEKTRISCHEN SCHLAGES NICHT ÖFFNEN

**VORSICHT: UM DAS RISIKO EINES ELEKTRISCHEN SCHLAGES ZU VERMINDERN, ABDECKUNG NICHT ENTFERNEN. KEINE BENUTZER BETRIEBUNGSTEILE IM INNERN. BETRIEBUNG NUR DURCH QUALIFIZIERTES BETRIEBUNGSPERSONAL.**

**CAUTION**  
RISK OF ELECTRIC SHOCK:  
OPEN ONLY IF QUALIFIED  
AS SERVICE PERSONNEL

**VORSICHT**  
GEFAHR EINES ELEKTRISCHEN SCHLAGES: NUR VON QUALIFIZIERTEM WARTUNGSPERSONAL ZU ÖFFNEN

To reiterate the above warnings: servicing instructions are for use by qualified personnel only. To avoid electric shock, do not perform any servicing other than that contained in the Operation Instructions unless you are qualified to do so. Refer all servicing to qualified service personnel

Eindringliche Warnung: Wartungsvorschriften dienen nur der Benutzung durch qualifiziertes Personal. Zur Vermeidung eines elektrischen Schlages keine anderen als die in den Betriebsvorschriften beschriebenen Wartungsarbeiten ausführen, es sei denn, Sie sind dafür qualifiziert. Wartungsarbeiten sind von qualifiziertem Wartungspersonal auszuführen.

# Table of Contents

---

<b>Cautions</b> .....	<b>1</b>
<b>Unit Description</b> .....	<b>3</b>
General Information .....	3
Open Input Architecture™ Slots .....	3
Feature Identification.....	4
<b>Installation</b> .....	<b>5</b>
Inputs .....	5
Outputs .....	5
Input Connections .....	6
Changing XLR Polarity.....	7
To Parallel the Inputs .....	7
Bridged Mono Mode .....	8
AC Power Connection.....	9
<b>Operation</b> .....	<b>10</b>
Controls .....	12
Gain Control Lockout.....	12
Displays.....	12
Typical Power Up, Operation, Power Down Behavior.....	12
Maximum Long-Term Output Power.....	14
Protection Circuits.....	14
<b>Specifications</b> .....	<b>16</b>
Power Output Ratings .....	17
<b>Troubleshooting</b> .....	<b>19</b>
<b>Illustrations</b>	
Figure 1. Open Input Architecture Slots.....	3
Figure 2. Rear and Front Views of 2-Space High Amplifiers .....	4
Figure 3. Rear and Front Views of 3-Space High Amplifiers .....	4
Figure 4. Neutrik Speakon Connector Wiring for Speaker Outputs .....	5
Figure 5. Typical Unbalanced Connection.....	6
Figure 6. Portable Balanced System .....	6
Figure 7. Installed Balanced System.....	6
Figure 8. Ground Bus Connection.....	6
Figure 9. Jumper Positions for XLR Polarity Reversal.....	7
Figure 10. Switch Settings for Bridged Mono Operation.....	7
Figure 11. Connection Options of Speaker Load for Bridged Mono .....	8
Figure 12. Speakon Connection Details for Bridged Mono Operation. ....	8
Figure 13. Gain Control Lockout.....	12
Figure 14. LED Displays During Normal Operation.....	13
Figure 15. LED Displays During Abnormal Operating Conditions .....	13
<b>Tables</b>	
Table 1. JBL MPA Series AC Power Consumption versus Load Impedance With 110, 115 & 120 V Mains .....	9
Table 2. JBL MPA Series AC Power Consumption versus Load Impedance With 220, 230 & 240 V Mains.....	10
Table 3. LED Display Operation .....	11
Table 4. Output Ratings With 110, 115 and 120 V Mains.....	16
Table 5. Output Ratings With 110, 115 and 120 V Mains.....	17

# Unit Description

---

The MPA275, MPA400, MPA600, MPA750 and MPA1100 are high-efficiency professional power amplifiers, with two independent channels, respectively capable of delivering 275, 400, 600, 750 and 1100 watts into a four ohm load (per channel), and substantially more power into lower impedance loads. Semi-toroidal power transformers (one per channel in the MPA750 and MPA1100) are mounted in each front corner, as close as possible to the rack ears and rails. The rear panels are 16.9 inches behind the front mounting plane, so an extra rack depth allowance (i.e., more than 18 inches) will be needed to clear XLR or Speakon connections. The built-in fan cooling takes air in the rear, exhausting through front vents. Due to the flow-through cooling, amplifiers may be racked with zero clearance in between, which also helps support the weight. Rear support within the rack must be used in portable applications.

## Open Input Architecture™ Slots

Provided with each MPA Series amplifier is a standard input module. This module and the upper input cover panel can be removed, permitting future upgrades. Internally, a ribbon cable runs behind both of these “slots.” The ribbon cable connects to the rest of the amplifier and carries several levels of DC power, and (for each channel) the input signals, speaker output monitor, muting status, clip activity, thermal status, and power-on status. These signals are provided to support future remote control and monitoring schemes as they become available. The JBL Marketing department will be happy to entertain suggestions for input modules.

The “standard input board” which is shipped with each amplifier has balanced XLR and barrier strip inputs, bridging and input-parallel switches, and footprints for passive rollofts and popular input isolation transformers (more info is available on request).

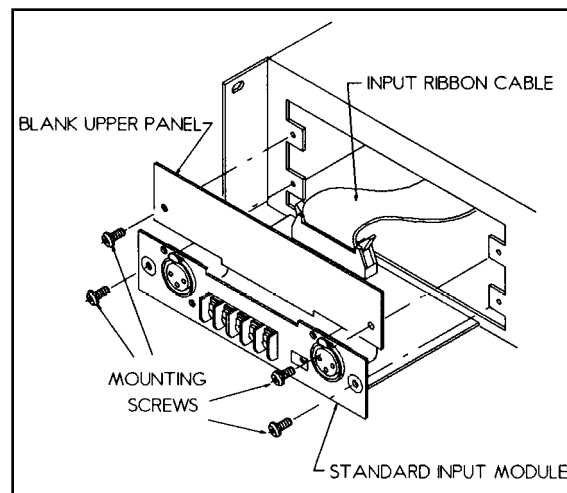

**Figure 1. Open Input Architecture Slots.**

# Unit Description

**Figure 2. Rear and Front Panel for 2-Space High Models (MPA275, MPA400 & MPA600)**

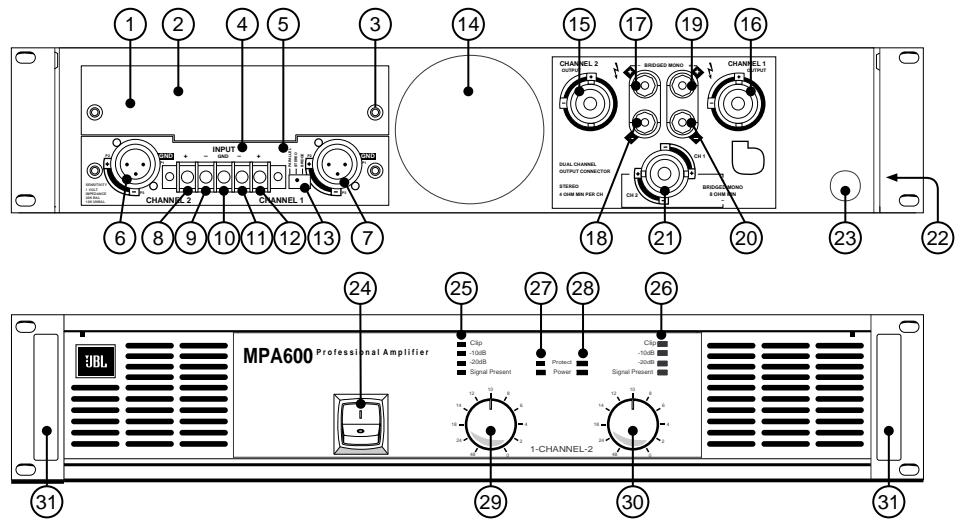

**Figure 3. Rear and Front Panel for 3-Space High Models (MPA750 and MPA1100)**

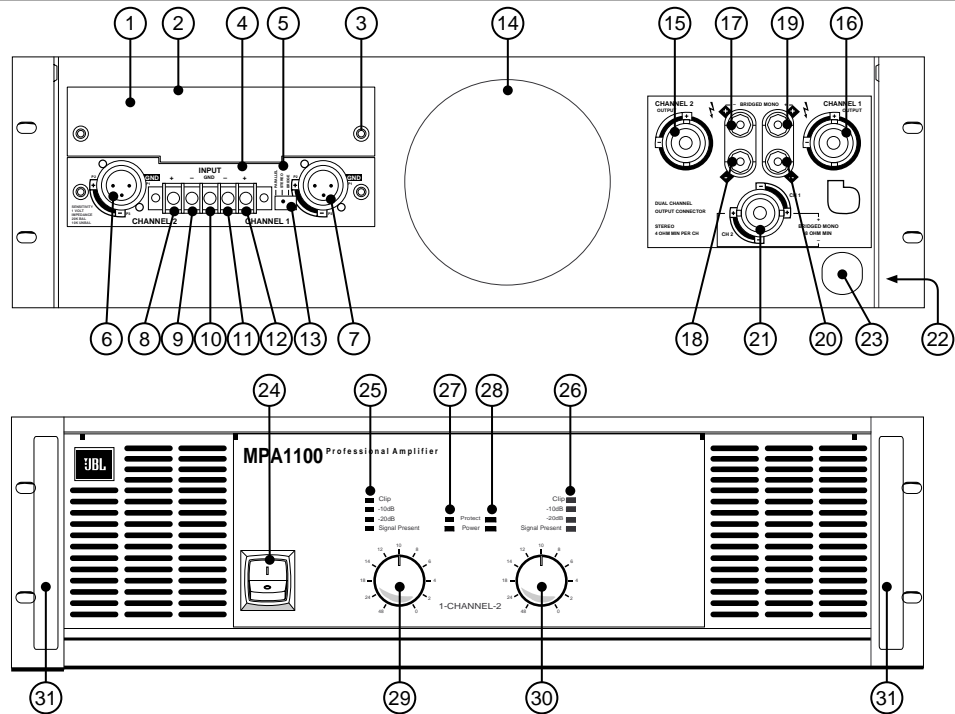

## Rear Panel Features

1. Upper Input Slot
2. Upper Input Cover Panel
3. Slot Product Mounting Screws
4. Lower Input Slot
5. Standard Input Board
6. Channel 2 XLR Input Connector
7. Channel 1 XLR Input Connector
8. Channel 2 (+) Terminal Block Input
9. Channel 2 (-) Terminal Block Input
10. Channel 1 & 2 Ground Terminal
11. Channel 1 (-) Terminal Block Input

## Front Panel Features

12. Channel 1 (+) Terminal Block Input
13. Configuration Selector Switch
14. Fan
15. Channel 2 Speakon Output Connector
16. Channel 1 Speakon Output Connector
17. Channel 2 (+) Binding Post \*
18. Channel 2 (-) Binding Post \*
19. Channel 1 (+) Binding Post \*
20. Channel 1 (-) Binding Post \*
21. Dual-Channel Out Speakon Connector
22. Rear Rack Support (Left and Right)
23. Power Cord

## Rear Panel Features

24. Unit Power Switch
25. Channel 1 Level Display
26. Channel 2 Level Display
27. Channel 1 Power & Protection Display
28. Channel 2 Power & Protection Display
29. Channel 1 Gain Control
30. Channel 2 Gain Control
31. Handle (Left and Right)

\*Banana output for 100–115 VAC Units Only

# Installation

---

## Inputs

Balanced input connections are available via barrier strip or XLR connectors. The unit is shipped with pin 2 high (see subsequent instructions to change polarity). As usual, for unbalanced inputs, the unused terminal should be terminated to ground (the negative input terminals on the barrier strip are located adjacent to the ground terminal for this purpose).

Input sensitivity is 1 Vrms, and impedance is 20 kilohm balanced, 10 kilohm unbalanced, as is typical of JBL amplifiers.

The input jacks are located on a removable panel which has a toggle switch for (1) bridged-mono (2) normal stereo, or (3) paralleling the inputs. See page 2 for more information about the Open Input Architecture slots.

## Outputs

Speaker connections are made via standard red/black 5-way binding posts, or by Neutrik NL4FC Speakon connectors. The Speakon for each channel uses the standard wiring of:

Pin 1-	=	Speaker Ground
Pin 1+	=	Speaker Hot
Pin 2-	=	[Not used]
Pin 2+	=	[Not used]

In addition, a central Speakon is provided with the standard stereo wiring of:

Pin 1-	=	Ch 1 Ground
Pin 1+	=	Ch 1 Hot
Pin 2-	=	Ch 2 Ground
Pin 2+	=	Ch 2 Hot

Connection Terminals

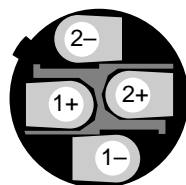

Exploded view (side)

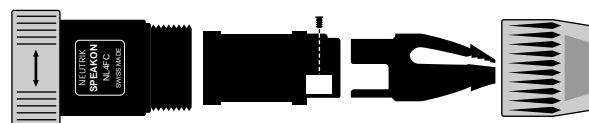

**Figure 4. Neutrik Speakon Connector Wiring for Speaker Outputs**

# Input Connections Xx

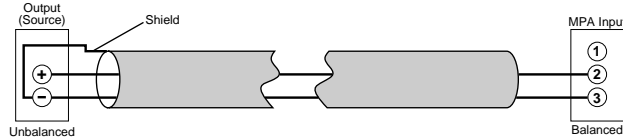

**Figure 5. Typical Unbalanced Connection**

To connect an unbalanced source to the input of an MPA amplifier, “+” should be connected to pin 2, and “-” to pin 3. The “-” terminal should also be connected to the shield at the source only. Pin 1 should not be connected at the amplifier.

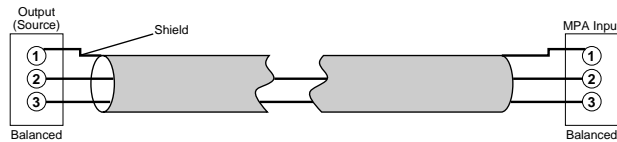

**Figure 6. Portable Balanced System**

In a portable system using a source unit with balanced outputs, a standard XLR cable wired pin to pin (with pin 1 connected to the shield at both ends) should be used.

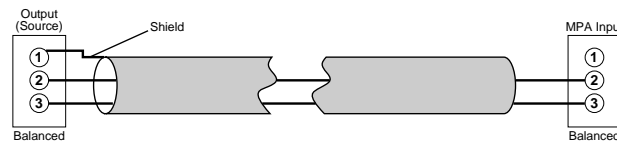

**Figure 7. Installed Balanced System**

In an installed system using a source unit with balanced outputs, pin 1 should be connected to the shield at the source, with no connection to pin 1 at the amplifier.

If, after wiring the input as shown above, any hum or buzzing is present, connect the GND terminals of all amplifiers together. This bus should then be connected to a stable earth ground. It may also be necessary to connect the chassis of the input source device to the ground bus, particularly when using an unbalanced source.

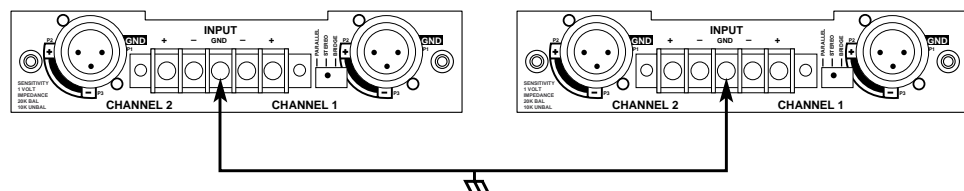

**Figure 8.**

# Installation



**Caution:**

The XLR polarity changes as outlined on this page should only be done by qualified personnel with “board level” soldering experience.

## Changing the XLR polarity

The MPA275, MPA400, MPA600, MPA750 and MPA1100 are shipped with XLR polarity set at pin 2 high. To convert to pin 3 high:

1. Remove the Standard Input Module and input ribbon cable. (See Figure 1).
2. Find the soldered jumpers W303, W304 (Ch 1) and W403, W404 (Ch 2), located behind each XLR jack. These are soldered in positions marked “PIN 2 HI”.
3. Desolder each jumper, and move it lengthwise 0.2 inches to its alternate mounting position (the end marked “PIN 3 HI”), and resolder. Each jumper should fit in its new position evenly without changing its length. All four must be moved or the input signal will not be properly connected. (See Figure 5).
4. Label the outside of the Input panel to show that pin 3 is now High.  
NOTE: THIS ADJUSTMENT DOES NOT ALTER THE POLARITY OF THE BARRIER STRIP, which remains as marked on the rear panel.
5. Install the input ribbon cable and remount the Standard Input Module securely.

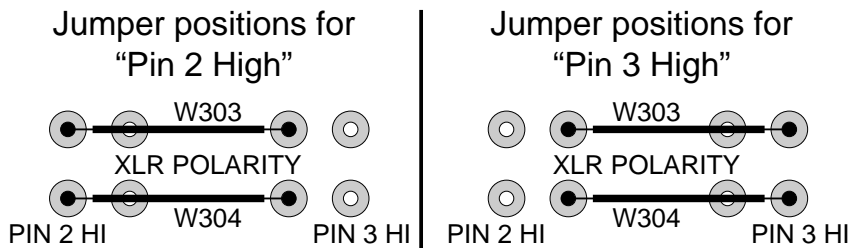
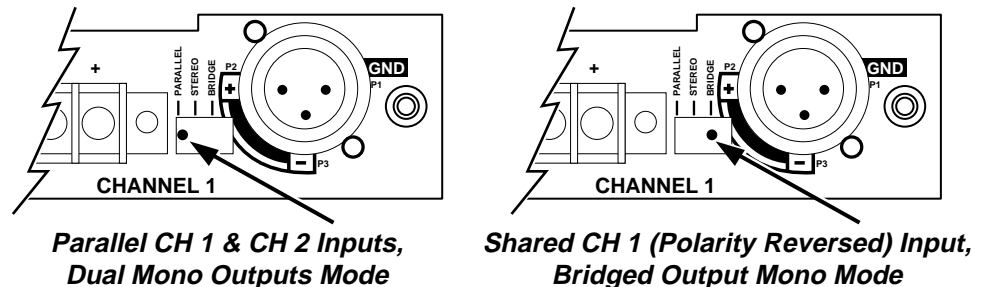

**Figure 9. Jumper Positions for XLR Pin 2 High (factory preset), and Pin 3 High.**

*Note: Both channels must be modified for proper polarity reversal.*

## To Parallel the Inputs

1. Locate the selector switch adjacent to the CHANNEL 1 input XLR connector, and set it to the PARALLEL position (see Figure 6 below, left).



**Figure 10. To Parallel the Input Jacks or for Bridged Mono, Set the Toggle Switch on the Standard Input Module as Shown Here.**



# Installation

With paralleled inputs, the signal may be looped through (or “daisy-chained”) by going in one channel’s inputs and out the other. The amplifier Gain settings will not affect the level at the input jacks.

## BRIDGED-MONO MODE CAUTION:

Output voltages up to 200 volts rms are available between the MPA1100’s bridged terminals (140 volts into an 8 ohm load). Even on the MPA600, 150 volts rms are available between the bridged terminals (103 volts into an 8 ohm load). Fully insulated CLASS ONE wiring must be used, and the load must be rated up to 2400 watts (8 ohms) on the MPA1100, 1500 watts on the MPA750, and 1330 watts (8 ohms) on the MPA600. While the MPA400 and MPA275 develop somewhat less power, precautions should be observed nonetheless.

## Bridged-Mono Mode

1. Locate the selector switch adjacent to the CHANNEL 1 input XLR connector, and set it to the BRIDGE position (see Figure 6, right side, on page 6).
2. Connect inputs to Ch 1 only. Do not connect anything to Ch 2 inputs.
3. Set Ch 2 Gain on FULL and regulate Gain with Ch 1 Gain only. Both channels should display the same LEVEL readouts.
4. A single speaker load is used. The positive lead may be connected to Ch 1 red binding post, and the negative lead to Ch 2 red binding post, but due to the high voltage present (see caution note) we recommend the use of the fully insulated Speakon connector. Both wiring options are shown in Figure 7.

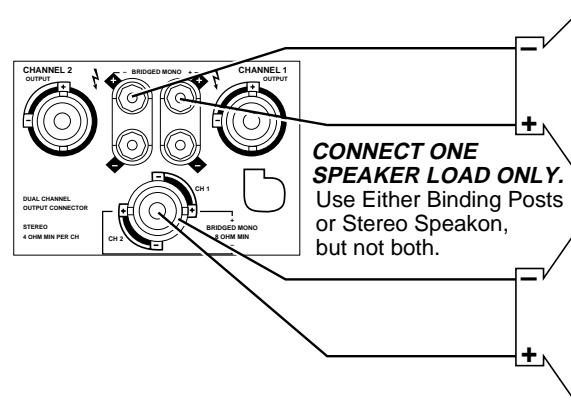

Figure 11. Connection Options of Speaker Load for Bridged Mono Operation.

### Speakon wiring for bridged mono, using the third, or “stereo” Speakon:

Connect speaker positive to pin 1+.

Connect speaker negative to pin 2+.

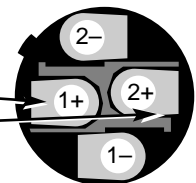

Figure 12. Speakon Connection Details for Bridged Mono Operation.

## VORSICHT BEIM ÜBERBRÜCKTEN MONO-MODUS:

Zwischen den überbrückten Terminals des MPA1100 (140 Volt bei einer Belastung von 8 Ohm) besteht eine Ausgangsspannung mit einem quadratischen Mittelwert von bis zu 200 Volt. Selbst beim MPA600 besteht eine Ausgangsspannung mit einem quadratischen Mittelwert von 150 Volt zwischen den überbrückten Terminals (103 Volt bei einer Belastung von 8 Ohm). Zu verwenden ist voll isolierte Verdrahtung der US-Klasse Eins, und die angeschlossene Belastung muß für bis zu 2400 Watt (8 Ohm) beim MPA1100, 1500 Watt beim MPA750 und 1330 Watt (8 Ohm) beim MPA600 ausgelegt sein. Obwohl die Leistung beim MPA400 und MPA275 etwas geringer ist, sind die Sicherheitsvorschriften dennoch einzuhalten.

# Installation

---

## **AC Power Connection**

AC Connection is made through a standard Schuko or NEMA grounded plug. While all models meet Safety Agency requirements for current consumption of less than 12 amp, 120 Vac during “normal” operation, peak current consumption can be higher on the MPA1100 or MPA750.

The amplifiers can be wired for 100, 120, or 220–240 Vac, 50–60 Hz.

Some background on AC ratings is necessary to fully understand the limitations on current draw. Essentially, there are three ratings of interest: (1) the legal operating current as measured by the Safety Agencies, (2) the maximum expected average under worst-case program material, and (3) the peak current draw at full output power.

All major safety agencies around the world measure amplifier current and temperature rise under the same “normal operating conditions” using a pink noise signal with an average power equal to one eighth of maximum power. This was in response to industry complaints that the former test level of one third power was unrealistic for high-quality professional amplifiers. To put these levels in perspective, music played at one third average power will be in a state of constant clipping, and this power level is about the greatest one can obtain without completely obliterating the program under clipping. The one eighth power level is about as loud as you can play music while making some attempt to avoid obvious clipping.

We had to satisfy the following conditions:

1. Meet the safety agency requirements for “normal” current draw.
2. Remain within the functional limits of the plug for “severe program levels.”
3. Avoid unsafe conditions at full output power.

The AC consumption for each power level and load impedance is shown in Table 1 and Table 2 (see pages 9 and 10).

The safety agencies are concerned with the current levels shown under the one eighth power column. This is because building codes prohibit the connection of a single load which exceeds 80% of the capacity of the branch circuit.

JBL Engineering standards call for ability to operate at one third power, in order to meet the demands of “worst-case” heavily compressed, clipped program material. This will use the AC current shown in the one third power column. The amplifier’s protective circuits will not permit long-term operation at full power into 2 ohms.

# Operation

## Operation With 110 VAC, 60 Hz Power Mains

Model	2 CH Load (Ohms)	Max Power (Midband)	AC Current Full Power	AC Current 1/3 Power	AC Current 1/8 Power	AC Current Idle
MPA1100	8+8	740 x 2	23.0 A	10.2A	5.4 A	0.9 A
	4+4	1000 x 2	38.0 A	16.0 A	7.8 A	
	2+2	1300 x 2	54.0 A	23.0 A	11.4 A	
MPA750	8+8	480 x 2	18.0 A	9.6A	4.6 A	0.7 A
	4+4	700 x 2	29.0 A	14.4 A	6.4 A	
	2+2	950 x 2	38.0 A	21.0 A	10.0 A	
MPA600	8+8	400 x 2	15.2 A	8.4 A	3.4 A	0.5 A
	4+4	550 x 2	22.0 A	13.5 A	5.4 A	
	2+2	675 x 2	32.0 A	15.2 A	8.0 A	
MPA400	8+8	275 x 2	11.2 A	6.6 A	2.6 A	0.4 A
	4+4	400 x 2	16.0 A	9.6 A	4.6 A	
	2+2	525 x 2	22.0 A	13.2 A	5.4 A	
MPA275	8+8	180 x 2	7.6 A	5.4 A	3.6 A	0.4 A
	4+4	275 x 2	12.0 A	7.2 A	5.2 A	
	2+2	425 x 2	18.2 A	11.2 A	7.0 A	

## Operation With 115 VAC, 60 Hz Power Mains

MPA1100	8+8	770 x 2	24.0 A	10.4 A	5.6 A	1.0 A
	4+4	1100 x 2	39.0 A	16.6 A	8.0 A	
	2+2	1400 x 2	56.0 A	23.4 A	11.8 A	
MPA750	8+8	510 x 2	18.6 A	9.8A	4.8 A	0.8 A
	4+4	760 x 2	30.0 A	14.8 A	6.8 A	
	2+2	1000 x 2	39.4 A	21.4 A	10.6 A	
MPA600	8+8	425 x 2	13.6 A	8.6 A	3.6 A	0.6 A
	4+4	610 x 2	23.0 A	13.4 A	5.6 A	
	2+2	750 x 2	33.0 A	15.6 A	8.6 A	
MPA400	8+8	290 x 2	11.6 A	6.8 A	2.8 A	0.4 A
	4+4	425 x 2	17.0 A	9.8 A	4.8 A	
	2+2	575 x 2	23.0 A	13.6 A	5.6 A.	
MPA275	8+8	190 x 2	7.8 A	5.6 A	3.8 A	0.4 A
	4+4	300 x 2	13.6 A	7.6 A	5.6 A	
	2+2	450 x 2	19.2 A	11.6 A	7.4 A	

## Operation With 120 VAC, 60 Hz Power Mains

MPA1100	8+8	800 x 2	25.0 A	10.8 A	5.8 A	1.0 A
	4+4	1200 x 2	40.0 A	17.0 A	8.4 A	
	2+2	1500 x 2	58.0 A	24.0 A	12.0 A	
MPA750	8+8	550 x 2	19.0 A	10.0 A	5.0 A	0.8 A
	4+4	825 x 2	31.0 A	15.2 A	7.4 A	
	2+2	1100 x 2	41.0 A	22.0 A	11.0 A	
MPA600	8+8	450 x 2	16.0 A	9.0 A	4.0 A	0.6 A
	4+4	675 x 2	24.0 A	14.0 A	6.0 A	
	2+2	825 x 2	34.0 A	16.0 A	9.0 A	
MPA400	8+8	300 x 2	12.0 A	7.0 A	3.0 A	0.4 A
	4+4	450 x 2	18.0 A	10.0 A	5.0 A	
	2+2	650 x 2	24.0 A	14.0 A	6.0 A.	
MPA275	8+8	200 x 2	8.0 A	6.0 A	4.0 A	0.4 A
	4+4	325 x 2	13.0 A	8.0 A	6.0 A	
	2+2	500 x 2	20.0 A	12.0 A	8.0 A	

**Table 1. JBL MPA-Series AC Power Consumption vs Load Impedance With 110, 115 and 120V Mains**

# Operation

## Operation With 220 VAC, 50 Hz Power Mains

Model	2 CH Load (Ohms)	Max Power (Midband)	AC Current Full Power	AC Current 1/3 Power	AC Current 1/8 Power	AC Current Idle
MPA1100	8+8	740 x 2	11.5 A	5.1A	2.7 A	0.5 A
	4+4	1000 x 2	19.0 A	8.0 A	3.9 A	
	2+2	1300 x 2	27.0 A	11.5 A	5.7 A	
MPA750	8+8	480 x 2	9.0 A	4.8A	2.3 A	0.4 A
	4+4	700 x 2	14.5 A	7.2 A	3.2 A	
	2+2	950 x 2	19.0 A	10.5 A	5.0 A	
MPA600	8+8	400 x 2	7.6 A	4.2 A	1.7 A	0.3 A
	4+4	550 x 2	11.0 A	6.5 A	2.7 A	
	2+2	675 x 2	16.0 A	7.6 A	4.0 A	
MPA400	8+8	275 x 2	5.6 A	3.3 A	1.3 A	0.2 A
	4+4	400 x 2	8.0 A	4.8 A	2.3 A	
	2+2	525 x 2	11.0 A	6.6 A	2.7 A	
MPA275	8+8	180 x 2	3.8 A	2.7 A	1.8 A	0.2 A
	4+4	275 x 2	6.0 A	3.6 A	2.6 A	
	2+2	425 x 2	9.1 A	5.6 A	3.5 A	

## Operation With 230 VAC, 50 Hz Power Mains

MPA1100	8+8	770 x 2	12.0 A	5.2 A	2.8 A	0.5 A
	4+4	1100 x 2	19.5 A	8.3 A	4.0 A	
	2+2	1400 x 2	28.0 A	11.7 A	5.9 A	
MPA750	8+8	510 x 2	9.3 A	4.9A	2.4 A	0.4 A
	4+4	760 x 2	15.0 A	7.4 A	3.4 A	
	2+2	1000 x 2	19.7 A	10.7 A	5.3 A	
MPA600	8+8	425 x 2	7.8 A	4.3 A	1.8 A	0.3 A
	4+4	610 x 2	11.5 A	6.7 A	2.8 A	
	2+2	750 x 2	16.5 A	7.8 A	4.3 A	
MPA400	8+8	290 x 2	5.8 A	3.4 A	1.4 A	0.2 A
	4+4	425 x 2	8.5 A	4.9 A	2.4 A	
	2+2	575 x 2	11.5 A	6.8 A	2.8 A	
MPA275	8+8	190 x 2	3.9 A	2.8 A	1.9 A	0.2 A
	4+4	300 x 2	6.3 A	3.8 A	2.8 A	
	2+2	450 x 2	9.6 A	5.8 A	3.7 A	

## Operation With 240 VAC, 50 Hz Power Mains

MPA1100	8+8	800 x 2	12.5 A	5.4 A	2.9 A	0.5 A
	4+4	1200 x 2	20.0 A	8.5 A	4.2 A	
	2+2	1500 x 2	29.0 A	12.0 A	6.0 A	
MPA750	8+8	550 x 2	9.5 A	5.0 A	2.5 A	0.4 A
	4+4	825 x 2	15.5 A	7.6 A	3.7 A	
	2+2	1100 x 2	20.5 A	11.0 A	5.5 A	
MPA600	8+8	450 x 2	8.0 A	4.5 A	2.0 A	0.3 A
	4+4	675 x 2	12.0 A	7.0 A	3.0 A	
	2+2	825 x 2	17.0 A	8.0 A	4.5 A	
MPA400	8+8	300 x 2	6.0 A	3.5 A	1.5 A	0.2 A
	4+4	450 x 2	9.0 A	5.0 A	2.5 A	
	2+2	650 x 2	12.0 A	7.0 A	3.0 A	
MPA275	8+8	200 x 2	4.0 A	3.0 A	2.0 A	0.2 A
	4+4	325 x 2	6.5 A	4.0 A	3.0 A	
	2+2	500 x 2	10.0 A	6.0 A	4.0 A	

**Table 2. JBL MPA-Series AC Power Consumption vs Load Impedance With 220, 230 and 240V Mains**

# Operation

## Controls

The front-mounted Gain controls have 11 detents for easy matching of levels. The Gain scale shows dB of attenuation from full gain, with positions for 0 (full), -2, -4, -6, -8, -10, -12, -14, 18, -24, and  $\infty$  (full off). Attenuation is accurate within 1 dB (down to -14 dB).

## Gain Control Lockout

Provided with each amplifier are two lockout knob caps. Carefully remove the Gain control knob (A), as shown in Figure 9. Cover the opening by snapping in the lockout knob cap (B). The Gain control can no longer be adjusted.

## Displays

The LED displays for each channel operate as follows:

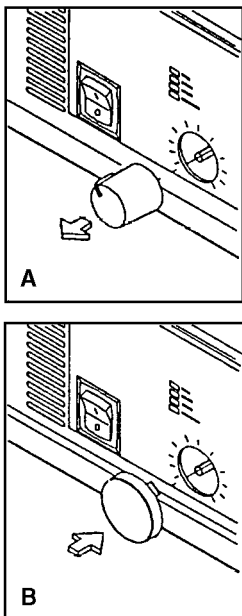

**Figure 13. Gain Control Lockout Installation**

LED Label	Color	Behavior
Power	Green	Main power supply active on this channel.
Signal Present	Green	Triggers at -36 dB below full output.
-20 dB	Green	Triggers at -23 dB.
-10 dB	Yellow	Triggers at -11 dB.
Clip	Red	Shows activity of Limiting circuit, which responds to both clipping and to thermal overload.
Protect	Red	Flashes as amplifier approaches maximum temperature. Illuminated steadily plus flashing during thermal muting. Illuminated steadily during non-thermal muting.

**Table 3. LED Display Operation**

## Typical Power Up, Operation, Power Down Behavior

When the amplifier is first turned on, the green POWER displays will light up for both channels, and there will be a 3 second turn-on delay, during which all red LEDs will be bright (PROTECT and CLIP). If a channel will not come out of muting, it may be responding to an excessive high frequency level at the input (see page 12, "Protection Circuits"). Turning down the Gain controls (before you power up the amp is best) allows the muting to release, and is always a good idea to prevent an unexpected input signal from overdriving the load.

Signal Level will be shown as the green Signal Present, -20dB and the yellow -10dB display illuminate with increasing signal level (see Figure 10 on next page).

When the amplifier is turned off, muting should be virtually instantaneous, with all red LEDs illuminated until the power supply discharges.

# Operation

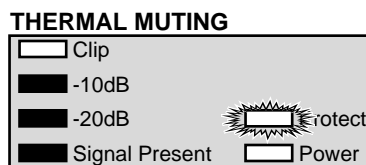
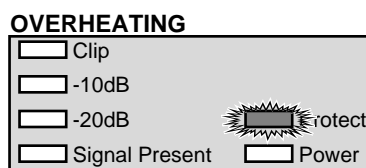
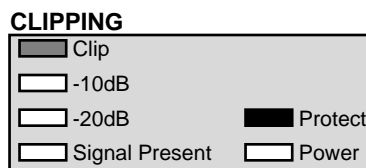
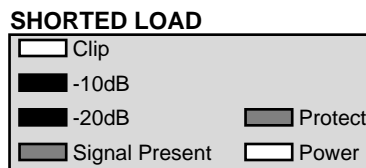
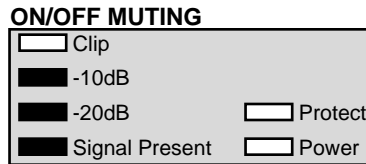
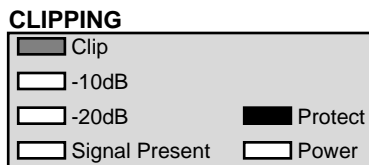
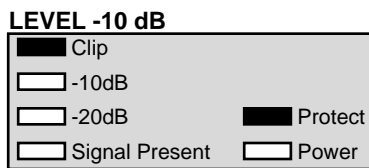
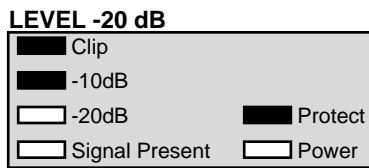
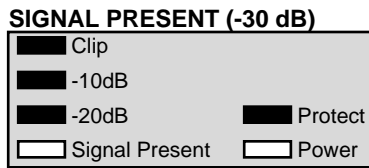
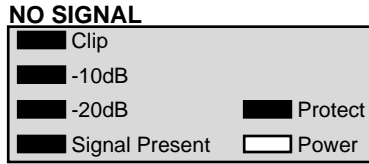

CLIP is illuminated at full brightness when the output is muted (PROTECT LED is on, too).

If CLIP is illuminated at less than full LEVEL display, the load is shorted or abnormal. PROTECT may flash, too.

CLIP flashing at full LEVEL display indicates the amp has reached full power (clipping) and the limiter is acting to prevent severe overdrive.

A steady CLIP glow after the flashing PROTECT display has started indicates the onset of thermal limiting.

PROTECT flashes as the amplifier approaches max temperature. Full brightness plus flashing indicates thermal muting.

**Figure 14. LED Displays During Normal Operation**

**Figure 15. LED Displays During Abnormal Operating Conditions**

**Key to LED representations:**

	Not Illuminated		Flashing
	Full Brightness		Full Bright & Flashing
	Variable or Occasional Flashing		

# Operation

---

## **Maximum Long-Term Output Power**

In most cases, the desired sound level can be obtained without using the full power output of the amplifier. The level displays are then used to confirm that both channels are working as desired.

If the amplifier is operated at extreme power levels, it may overheat or the speakers may be damaged. The following guidelines will help you determine how much power can be delivered to the speakers without thermal limiting (which is indicated by flashing of the red PROTECT display).

### **8 Ohm Loads**

The amplifier can be played at practically any volume without overheating. However, if the amplifier is pushed into continuous triggering of the CLIP display, the average output power can reach higher levels than most speakers will take.

### **4 Ohm Loads**

The amplifier's maximum long-term power capacity will be reached when the LEVEL -10 is on almost all the time, with occasional flashing of the CLIP display. If the CLIP display is on half the time, the amplifier is liable to start indicating thermal limits are being approached in a few minutes (full brightness flashing of the PROTECT LED).

### **2 Ohm Loads**

To avoid overheating on those models rated at 2 ohms (see Specifications), the LEVEL -10 display should not be on more than about half the time, with only occasional clipping.

## **Protection Circuits**

The essence of high-efficiency, lighter-weight designs is to control more power with fewer or smaller load-bearing components. The MPA275, MPA400, MPA600, MPA750 and MPA1100 represent a considerable step forward, with high efficiency due to the multi-step power supplies. Because of the higher power flow, effective protection circuits become even more important.

The inputs are resistively buffered for overload and RF protection. Chassis bypass capacitors are installed at inputs and outputs to further improve RF rejection.

All models have short circuit protection that is based on averaging the output power. This protection circuit permits full output current into resistive or reactive 2 ohm loads, but if the output is shorted, the current is cut back to a safe level of about 25%.

Turn-on/off muting prevents transients from the amplifier or preceding devices from reaching the speakers. The MPA275, MPA400, MPA600, MPA750 and MPA1100 use simultaneous relay and electronic muting to guarantee minimum possible on/off noise. The limiter (see subsequent paragraphs) is fully activated during muting, so that its release time cushions the onset of full volume. The turn-on delay has been

# Operation

---

extended somewhat, and the turn-off muting has been quickened, to ensure muting even of poorly designed preceding components. On/off muting is equally effective whether the amplifier is turned off with its own switch or with a remote switch.

Inrush current is limited by an NTC resistor (Negative Temperature Coefficient) which starts at a high resistance and then diminishes after turn-on to avoid loss of power. The amplifier's inrush current is no more severe than amplifiers of one half to one third its power rating.

DC Fault protection uses a load grounding relay.

Careful attention has been paid to thermal tracking and response. Sensors are located on each power transformer, as well as each channel's heat sink, so that overheating of either component will trigger the thermal defenses. Instead of an abrupt amplifier shutdown at the temperature limit, we now have 4 levels of response. At temperatures of 50° to 65° C, the fan speed is elevated from slow to full, to improve cooling as needed with the minimum possible noise. At temperatures of about 75° C, the red PROTECT LED begins to flash at a gradually increasing rate. At 85° C, the limiter circuit begins to reduce gain, which is shown by progressively brighter illumination of the red CLIP LED. At 90° C, gain is reduced by the maximum amount of 15 dB. If this does not arrest the temperature rise (in case of an output short or blocked ventilation), the amplifier will finally enter full muting, which causes full shutdown of the output bias circuit. Thermal tracking can be monitored at the input slot (see below).

Clipping activates a "Clip-Limit" circuit. This permits the amp to reach the point of clipping without premature limiting, for exceptional headroom capability. However, once clipping is reached (for any reason), input volume is then limited to prevent gross clipping. This circuit limits distortion caused by clipping to about 1% to 10% (depending on degree of overdrive), which is audible but not severe.

An ultrasonic detector mutes the amplifier in case of gross overloads above 20 kHz, to prevent load or amplifier burnout. The amplifier will reproduce high frequencies into normal loads without muting, but if the amp is turned on with high-level, high frequency input above 10 kHz, the amplifier will not come out of turn-on muting (this applies to full-level pink noise as well). This feature is intended to protect high frequency drivers from accidental burnout due to high frequency system oscillations, etc.

While not a protection feature in its own right, the remote monitoring capability built into the input slot provides the foundation for computer control and monitoring as such systems become available. The input slot has lines to read the status (for each channel) of power-on, input level, speaker level, thermal level, clip, protect, and mute status.



# Specifications

## General Specifications

<b>DISTORTION</b>	SMPTE-IM, less than 0.05 %		
<b>FREQUENCY RESPONSE</b>	20 Hz to 20 kHz, $\pm 0.1$ dB 8 Hz to 100 kHz, $\pm 0/3$ dB		
<b>DAMPING FACTOR</b>	Greater than 200		
<b>DYNAMIC HEADROOM</b>	3 dB at 4 ohms (2 dB for MPA275)		
<b>NOISE</b>	100 dB below rated output (20 Hz to 20 kHz)		
<b>SENSITIVITY</b>	1 Vrms for rated power (8 ohms)		
<b>VOLTAGE GAIN</b>	MPA1100:	80	(38 dB)
	MPA750:	63	(36 dB)
	MPA600:	56	(35 dB)
	MPA400:	45	(33 dB)
	MPA275:	35.5	(31 dB)
<b>INPUT IMPEDANCE</b>	10 kilohms unbalanced, 20 kilohms balanced		
<b>CONTROLS</b>	Front: AC switch, Ch 1 & Ch 2 Gain (2 dB detents). Rear: One toggle switch for paralleling inputs and for bridged output configuration		
<b>INDICATORS (each channel)</b>	POWER:	Green LED	
	SIGNAL PRESENT:	Green LED	
	LEVEL -20:	Green LED	
	LEVEL -10:	Yellow LED	
	CLIP:	Red LED	
	PROTECT:	Red LED (flashes for over-temp)	
<b>CONNECTORS (each chan., except one stereo Speakon)</b>	Input:	Barrier strip and XLR	
	Speakers:	5-way binding posts, Speakon connectors, st. Speakon**	
<b>COOLING</b>	Continuously variable speed fan, rear-to-front air flow		
<b>AMPLIFIER PROTECTION</b>	Full short circuit†, open circuit, ultrasonic, and RF protection, thermal limiting/muting; stable into reactive or mismatched loads		
<b>LOAD PROTECTION</b>	On/off muting, clip limiting, DC-fault load grounding relay with internal fault fuses		
<b>OUTPUT CIRCUIT TYPE</b>	Complementary linear, high-efficiency outputs: 3-step on MPA1100; 2-step on MPA750, MPA600 & MPA400; 1 step on MPA275		
<b>POWER REQUIREMENTS</b>	100, 120, 220–240 Vac, 50–60 Hz		
<b>POWER CONSUMPTION</b>	See Charts on pages 9 and 10.		
<b>DIMENSIONS</b>	48.3 cm (19") rack mounting, 45.5 cm (17.9") deep (rear support ears), MPA1100 & MPA750 are 13.3 cm (5.25") high (3 spaces); MPA600, MPA400 & MPA275 are 8.9 cm (3.5") high (2 spaces)		
<b>WEIGHT</b>	MPA1100:	29 kg (64 lbs) net, 31.8 kg (70 lbs) shipping	
	MPA750:	24.9 kg (55 lbs) net, 26.8 kg (59 lbs) shipping	
	MPA600:	20 kg (44 lbs) net, 22.2 kg (49 lbs) shipping	
	MPA400:	19.1 kg (42 lbs) net, 21.2 kg (47 lbs) shipping	
	MPA275:	18.1 kg (40 lbs) net, 20.4 kg (45 lbs) shipping	

Continued

\*\* For mating cable, use Neutrik NL4FC connector.

†Output Averaging™ short circuit protection (US Patent 4,321,554).

# Specifications

Load & Measurement Conditions	60 Hz AC Power Mains	Output RMS Power in Watts				
		MPA1100	MPA750	MPA600	MPA400	MPA275
8 ohms/channel 20 Hz – 20 kHz 0.1% THD	110 VAC		450	350	250	160
	115 VAC		475	375	260	170
	120 VAC		500	400	275	175
8 ohms/channel 20 Hz – 15 kHz * 0.1% THD	110 VAC	660				
	115 VAC	690				
	120 VAC	720				
4 ohms/channel 20 Hz – 20 kHz 0.1% THD	110 VAC		650	500	350	225
	115 VAC		700	550	375	250
	120 VAC		750	600	400	275
4 ohms/channel 20 Hz – 15 kHz * 0.1% THD	110 VAC	900				
	115 VAC	1000				
	120 VAC	1100				
8 ohms/channel 1 kHz 1% THD	110 VAC	740	480	400	275	180
	115 VAC	770	510	425	290	190
	120 VAC	800	550	450	300	200
4 ohms/channel 1 kHz 1% THD	110 VAC	1000	700	550	400	275
	115 VAC	1100	760	610	425	300
	120 VAC	1200	825	675	450	400
2 ohms/channel 1 kHz 0.1% THD, ±1 dB	110 VAC	1200	900	650	500	350
	115 VAC	1300	950	725	550	375
	120 VAC	1400	1000	800	600	400
8 ohms bridged mono 20 Hz – 20 kHz 0.1% THD	110 VAC		1300	1000	700	450
	115 VAC		1400	1100	750	500
	120 VAC		1500	1200	800	550
8 ohms bridged mono 20 Hz – 15 kHz * 0.1% THD	110 VAC	1800				
	115 VAC	2000				
	120 VAC	2200				
4 ohms bridged mono 1 kHz 0.1% THD, ±1 dB	110 VAC	2400	1800	1300	1000	700
	115 VAC	2600	1900	1450	1100	750
	120 VAC	2800	2000	1600	1200	800

**Table 4. Output Power Ratings When Used With 110, 115 & 120 VAC 60 Hz Mains**

# Specifications

Load & Measurement Conditions	50 Hz AC Power Mains	Output RMS Power in Watts				
		MPA1100	MPA750	MPA600	MPA400	MPA275
8 ohms/channel 20 Hz - 20 kHz 0.1% THD	220 VAC 230 VAC 240 VAC		450 475 500	350 375 400	250 260 275	160 170 175
8 ohms/channel 20 Hz - 15 kHz * 0.1% THD	220 VAC 230 VAC 240 VAC	660 690 720				
4 ohms/channel 20 Hz - 20 kHz 0.1% THD	220 VAC 230 VAC 240 VAC		650 700 750	500 550 600	350 375 400	225 250 275
4 ohms/channel 20 Hz - 15 kHz * 0.1% THD	220 VAC 230 VAC 240 VAC	900 1000 1100				
8 ohms/channel 1 kHz 1% THD	220 VAC 230 VAC 240 VAC	740 770 800	480 510 550	400 425 450	275 290 300	180 190 200
4 ohms/channel 1 kHz 1% THD	220 VAC 230 VAC 240 VAC	1000 1100 1200	700 760 825	550 610 675	400 425 450	275 300 325
2 ohms/channel 1 kHz 0.1% THD, ±1 dB	220 VAC 230 VAC 240 VAC	1200 1300 1400	900 950 1000	650 725 800	500 550 600	350 375 400
8 ohms bridged mono 20 Hz - 20 kHz 0.1% THD	220 VAC 230 VAC 240 VAC		1300 1400 1500	975 1075 1175	675 725 775	425 475 525
8 ohms bridged mono 20 Hz - 15 kHz * 0.1% THD	220 VAC 230 VAC 240 VAC	1800 2000 2200				
4 ohms bridged mono 1 kHz 0.1% THD, ±1 dB	220 VAC 230 VAC 240 VAC	2400 2600 2800	1800 1900 2000	1300 1450 1600	1000 1100 1200	700 750 800

**Table 5. Output Power Ratings When Used With 220, 230 & 240 VAC 50 Hz Mains**

\*Amplifier's output protective circuitry prevents full power output above 15 kHz.

***Specifications subject to change without notice.***

# Troubleshooting

---

## **Channel will not come out of muting:**

- A. If reducing Gain to zero does not release muting, the channel is defective or overheated (see below).
- B. If reducing Gain releases the muting, advance Gain slowly while watching the LEVEL displays (in case there is an abnormal signal which could blow the speakers).

## **No sound is heard:**

- A. Is the channel in muting? (PROTECT is bright, see below).
- B. If the LEVEL displays are active, (1) the speaker is open (blown), (2) there is an open circuit in the speaker wiring, or (3) there is an open circuit in the internal output wiring of the amplifier. (Consult a JBL dealer for service.)
- C. If there is no LEVEL (SIGNAL PRESENT, -20dB, -30dB) or CLIP displays, (1) there is no input signal, or (2) the ribbon cable to the input module may not be seated well.
- D. If the CLIP display is bright or peaking with little or no LEVEL display, this indicates shorted speaker line (especially if PROTECT starts flashing).

## **Channel goes into muting (temp-protect LED is on):**

- A. If flashing of the PROTECT display is visible, amplifier has muted due to extreme overheating. Fan should be running at full speed, and unless ventilation is blocked, operation should resume within one minute.
- B. The amplifier will mute in response to extreme high frequency overdrive, and output will not be restored until the frequency or level is lowered. Try turning down the Gain control to release muting, and determine the source of abnormal frequencies.
- C. Muting which does not respond to either condition suggests DC shutdown or other amplifier fault.

## **Hum Problems:**

- A. Ground lift of the signal is not available in these amplifiers due to the design which utilizes grounded-collector transistor mounting to improve thermal efficiency. Low-emission AC transformers are used, and balanced inputs afford hum rejection. If hum persists despite the balanced inputs, check the tightness of the rear panel screws which hold the input panel in place (two outer screws, and two screws holding barrier strip). If the input wiring is near SCR (silicon controlled rectifier) dimmers, transformer-isolated inputs may be necessary because of the exceptionally high noise field voltages generated by SCRs.

# Troubleshooting

---

## **Overheating:**

- A. If ventilation is blocked, or if the amplifier is overdriven into low impedance loads, it can overheat. The thermal protection system's normal response to rising temperatures is as follows:
  - 25–50° C: Fan runs on low speed.
  - 50–60° C: Fan Speed rises gradually from slow to full.
  - 75° C: PROTECT LED starts flashing.
  - 85° C: PROTECT flash rate increases, and CLIP starts to glow steadily. The limiter will begin to reduce amplifier gain, up to 15 dB.
  - 90° C: Full muting occurs, as indicated by bright CLIP display and bright PROTECT display (with rapid flashing superimposed). Full muting should occur only if the load is shorted, ventilation is completely blocked, or the fan fails.

# For Further Assistance

---

## **General information or Technical Assistance**

For more information on JBL products, including these power amplifiers, contact your nearest JBL professional products dealer or the JBL factory at the address below.

## **Repairs**

Please do not ship your amplifier(s) to JBL or a JBL authorized repair facility without prior authorization. You may obtain that authorization by contacting the factory or repair facility directly. Please ship amplifiers in original packing materials or equivalent to prevent further damage during shipment, and insure the shipment adequately. Mark the return materials authorization number (RMA) clearly on the outside of the package and on any correspondence.

JBL Incorporated  
8500 Balboa Boulevard  
Northridge, California 91329 USA  
Telephone (818) 893-8411



JBL Incorporated  
8500 Balboa Boulevard  
Northridge, California 91329USA