

DSC260

Digital System Controller

Owners Manual



PROFESSIONAL

8500 Balboa Blvd.
Northridge, CA 91329

TABLE OF CONTENTS

1.0 INTRODUCTION 1

2.0 GETTING STARTED..... 2

 2.1 UNPACKING..... 2

 2.2 MECHANICAL MOUNTING 2

 2.3 AC POWER CONNECTIONS 2

 2.4 AUDIO CONNECTIONS 2

 2.5 CONTROLLER CONNECTIONS..... 2

3.0 A QUICK START 3

4.0 GENERAL OPERATION..... 4

 4.1 LED INPUT BARGRAPHS 4

 4.2 LED OUTPUT BARGRAPH 4

 4.3 MUTE 4

 4.4 STORE(ENTER) AND RECALL..... 4

 4.5 PLUS AND MINUS..... 4

 4.6 LCD DISPLAY SCREEN 4

 4.7 ACCESS BUTTONS..... 5

5.0 UTILITY CONTROL PARAMETERS..... 6

 5.1 STEREO LINK 6

 5.2 DEVICE CONFIGURATION 7

 5.3 DELAY UNITS..... 7

 5.4 LOCK OUT..... 8

 5.5 MIDI CHANNEL 8

 5.6 CONTRAST 8

 5.7 OEM LOCK..... 8

 5.8 MIDI DUMP 8

 5.8 PROGRAM DELETE..... 9

6.0 INPUT SECTIONS..... 11

 6.1 INPUT DELAY 11

 6.2 INPUT EQ..... 11

7.0 OUTPUT SECTION NAME, SOURCE, DELAY AND POLARITY 12

 7.1 NAME 12

 7.2 INPUT SOURCE..... 12

 7.3 OUTPUT GAIN 12

 7.4 LIMITER THRESHOLD 12

 7.5 VARIABLE OUTPUT DELAY..... 13

 7.5 DELAY LINKING 14

 7.6 SWITCHABLE POLARITY..... 14

8.0 OUTPUT CROSSOVER SLOPES AND FREQUENCIES..... 15

 8.1 LOW EDGE FILTER TYPE 15

 8.2 LOW EDGE FILTER FREQUENCY 16

 8.3 HIGH EDGE FILTER TYPE..... 16

 8.4 HIGH EDGE FILTER FREQUENCY 16

9.0 ASSIGNABLE EQ	17
9.1 EQ TYPE	17
9.2 EQ FREQUENCY	18
9.3 EQ CUT/BOOST	18
9.4 EQ BANDWIDTH	18
9.5 MORE THAN YOU PROBABLY WANT TO KNOW ABOUT FILTER/EQ ASSIGNMENT	19
10.0 STORE, RECALL AND SECURITY	20
10.1 PROGRAM NAMING	20
10.2 PROGRAM STORING	20
10.4 PROGRAM RECALL.....	20
10.5 SECURITY SETTINGS	21
11.0 TECHNIQUES, TRICKS AND TRAPS.....	23
11.1 USE BOTH HANDS.....	23
11.2 OH, WHERE HAS MY OUTPUT GONE?.....	23
11.3 DELAYS IN 1, 2, 3 STEPS.....	23
11.5 I'M TRYING TO ADJUST THE CROSSOVER OR EQ BUT IT WON'T GO AS HIGH OR AS LOW AS I WANT	23
11.6 I CAN'T GET THE DELAY TO GO TO IT'S MAXIMUM OF 635 MS	23
11.7 I DON'T HAVE ANY LINKED DELAYS, BUT I CAN'T GET THE MAXIMUM 630MS OUT OF THE UNIT	23
11.8 "WARNING, NO MORE FILTERS"	23
11.9 THE DSC260 HAS A SPLIT PERSONALITY	23
11.10 START WITH THE BASS.....	23
11.11 I'VE DONE IT YOUR WAY BUT I NEED MORE EQ ON INPUTS OR OUTPUTS 1 & 2.....	24
12.0 SPECIFICATIONS	25
APPENDIX A: CONNECTOR WIRING INFORMATION.....	26
APPENDIX B: OUTPUT ASSIGNMENT MATRIX FOR JBL SYSTEMS.....	27
APPENDIX C: MIDI IMPLEMENTATION	29
DSC-260 MIDI SYSEX FORMAT	29
OVERWRITE MEMORY REQUEST.....	29
DELETE ALL REQUEST.....	30
SYSTEM DUMP REQUEST.....	30
PROGRAM DUMP MESSAGE	31
APPENDIX D: USER PROGRAM TEMPLATES	32

0.0 Safety Information

Explanation of Graphic Symbols



The lightning flash with the arrowhead symbol, within an equilateral triangle, is intended to alert the user to the presence of insulated “dangerous voltage” within the product’s enclosure that may be of sufficient magnitude to constitute a risk of electric shock to humans.

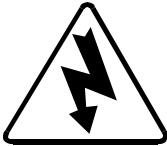

The exclamation point within an equilateral triangle is intended to alert the users to the presence of important operating and maintenance (servicing) instructions in the literature accompanying the product.



DO NOT EXPOSE
TO RAIN OR MOISTURE!



NE PAS EXPOSER À
LA PLUIE NI À L'HUMIDITÉ!

**CAUTION: TO REDUCE THE RISK OF ELECTRIC SHOCK
DO NOT REMOVE COVER.**

NO USER SERVICEABLE PARTS INSIDE.

REFER SERVICING TO QUALIFIED PERSONNEL

**ATTENTION: POUR EVITER LES RISQUES DE CHOC
ELECTRIQUE, NE PAS ENLEVER LE COUVERCLE. AUCUN ENTRETIEN DE PIECES
INTERIEURES PAR L'USAGER. CONFIER L'ENTRETIEN AU PERSONNEL QUALIFIE. AVIS:
POUR EVITER LES RISQUES D'INCENDIE OU
D'ELECTROCUTION, N'EXPOSEZ PAS CET ARTICLE A LA PLUIE OU A L'HUMIDITE.**

All DSC260 products are fitted with a detachable power cord (supplied) which connects to the chassis AC connector. The power cord has an IEC female connector on one end and a male mains connector on the other end. This cord is supplied specifically to accommodate the different safety and electrical code requirements of individual countries. The power cord supplied with your DSC260 has a 3-pin type plug. Do not cut off or damage the grounding pin.

If you are traveling abroad with your system, test the power mains and be aware of any specific voltage requirements. If you are in doubt, have a qualified electrician inspect and correct the condition. The input voltage and frequency is listed on the label near the IEC power input connector. JBL is not liable for product damage sustained by improper AC mains power connection.

JBL Professional
8500 Balboa Blvd.
Northridge, CA 91329
U.S.A
Tel: 1 (818) 894-8850
Fax: 1 (818) 830-1220
Web: www.jblpro.com

The information contained in this document is confidential and copyright of JBL Professional. To convey its contents, in part or in whole to any third party without prior written authorization is a violation of the copyright. (c) JBL Professional 1997.

1.0 Introduction

Thank you for purchasing the JBL DSC260 Digital System Controller, a specialized device designed for overall system control. It provides electronic crossover, transducer equalization, signal alignment, level matching and protection limiting for your system. Its advanced design and high quality components, coupled with in-depth acoustical measurements and extensive listening tests, provides superior sonic performance. By integrating the various system control requirements into one package, the DSC260 offers unparalleled performance for touring, fixed installation and monitoring requirements.

The DSC260 can be set up in many different configurations offering ultimate flexibility. Mono, two way and three way defaults are included. The user can also program additional configurations such as mono four, five or six way. Other configurations include mono four way with the second input feeding either a separate 2 way systems such as a down fill or delay cluster. The DSC260 flexibility is only limited by the maximum number of inputs and outputs and the users imagination

This manual contains the information necessary to properly set-up and operate your JBL System. The maximum output capability of your system and its safe operation depends on the controller's setting and your chosen amplifiers. Carefully follow this manual's instructions for a long and productive relationship with your system.

The DSC260 contains the following:

- Active crossover filters with up to 48dB/Octave slopes to divide the audio spectrum into separate passbands for each transducer. Six outputs can be derived from either of the two inputs or a sum of both.
- Up to thirty eight bands of parametric or shelving equalization for smoothing system frequency response over the entire bandwidth and to provide uniform high frequency power response. (Dependant upon crossover filter requirements)
- 60 storage registers for individual programs including several JBL specific programs such as Array, Architectural, HLA, SR and DMS
- Signal delay on inputs and outputs for delay towers and clusters as well as transducer alignment with up to 630ms in 21µs steps.
- Output limiters to protect system transducers from overload damage with adjustable thresholds and automatic attack and release settings based on crossover frequency for full musical dynamics.
- Convenient front panel controls for channel muting programming and level information.

Additional Features

- Security LockOut modes for protecting and hiding program settings
- Delay units are selectable in meters, feet or milliseconds
- Polarity reversal on each output
- Digital gain adjustment from -25 to +4 dB
- MIDI sysex dump utilities to save and transfer programs between units and archive settings
- Mutes on each output

2.0 Getting Started

2.1 Unpacking: Carefully unpack the controller and inspect it for possible concealed shipping damage. Save the packing in case any damage is discovered and contact the dealer from whom you purchased the controller. In the event the DSC260 is ever shipped outside of a rack, keep the packing for reuse.

2.2 Mechanical Mounting: The DSC260 occupies one standard rack space (1U). When mounted in an equipment rack that is transported, it should be supported by a shelf or other equipment to prevent flexing of the mounting ears.

2.3 AC Power Connections: A 3-wire grounded outlet must always be used. The DSC260 will accept input AC from 100 - 240 Volts, 50-60 Hz. The DSC260 does not have a power switch and must be shut down by removing the IEC power connector.

WARNING: THIS DEVICE MUST BE GROUNDED!

The ground terminal of the IEC plug is required by wiring codes and regulations. It must always be connected to the electrical installation safety ground. The DSC260 has carefully designed internal grounding and balanced inputs and outputs to reduce the chance of ground loops (hum). If hum occurs see Appendix A for suggested correct audio signal wiring and system grounding. Replace fuse only with a new fuse of correct size (20 mm) and rating (T1A250v).

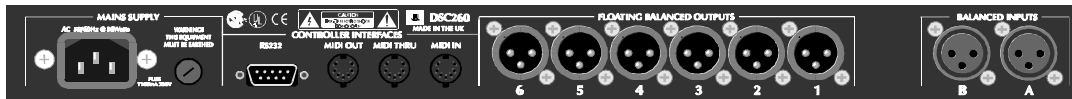

Figure 1 DSC260 Back Panel

2.4 Audio Connections: The DSC260 has two balanced inputs and six balanced outputs that can accommodate both balanced and unbalanced signals and are wired with Pin 2 hot. The two female XLR inputs are balanced, with pin 1 isolated to prevent ground loops. The six male XLR outputs are balanced, with pin 1 connected to ground. Pin 2 or pin 3 can be used as "hot" provided that the inputs and outputs are wired to the same standard. Two conductor shielded audio cable should always be used for all inputs and outputs.

Note: Because the DSC260 outputs can be programmed for any passband, caution must be taken when connecting the outputs to the amplifiers. Miswiring can connect low frequency information to high frequency drivers causing serious damage (not covered by warranty) to the drivers.

2.5 Controller Connections: MIDI in, out and thru jacks are located on the back panel. These allow remote program recall and MIDI sysex dump capability. In addition, an RS-232 connector allows updating of the Flash Memory as software updates become available. More information on these procedures is contained in Appendix C.

3.0 A Quick Start

To fully understand the operation and programming of the DSC260, the user should read at least sections 4 through 6. But since we know that most users have already plugged the unit in and started to explore, here is a quick start to get you up and running if you have a JBL system that is already programmed in the DSC260.

1. Before making any connections between the controller and the amplifiers, make sure that all power to the amplifiers is disconnected and their level controls are completely down.
2. The DSC260 has been programmed for many popular JBL Speaker System models. Before connecting the controller to the amplifiers, this program should be changed to a setting that matches your JBL system. Appendix B lists the various output assignments.
3. Select the appropriate program by powering on the DSC260 then pressing **RECALL**. Use the Parameter **Plus** and **Minus** buttons located on the left side of the LCD panel to page up and down until the correct setting is visible. Press **RECALL** after the cursor is on the setting.
4. Connect the console outputs to the inputs of the DSC260. Left to A and Right to B. In the case of a mono system, use input A.
5. Connect the outputs of the controller to the amplifier input channels maintaining the Left and Right identification. Typically the higher the number of the output, the higher the frequency content. i.e. In a 2 channel 3 way default, outputs 1 & 2 are Low, 3 & 4 are Mid and 5 & 6 are High. As the outputs vary depending upon the type of system and program loaded into the DSC260, consult Appendix B for correct output information.
6. Turn on the power to the console, controller(s) and finally the amplifiers. (It is best to turn the amplifiers on last and off first to prevent any thumps or pops from damaging the transducers.)
7. Apply a signal source to the controller. This can be pink noise, a tone or music.
8. Unmute the outputs on the DSC260, one at a time. The RED LEDs below each Output Meter signify the output is muted.
9. Advance each amplifier channel slowly and confirm that the signal reaching the transducers is correct. (It is best to begin with channels driving the low frequency transducers first. In this way, if the high and low are reversed, high frequency signals will be going to the woofer. It's better to find this problem than the low frequencies going to the high frequency device!)
10. After it is confirmed that all transducers are receiving the proper signals, initial calibration can begin.

4.0 General Operation

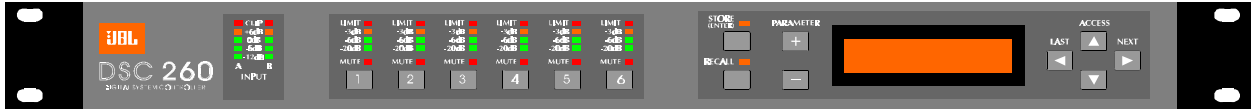

Figure 2 DSC260 Front Panel

4.1 LED Input Bargraphs The input bargraphs are peak responding to the input signal and also indicates digital clipping. The inputs always show the input level as calibrated to the XLR inputs. i.e. (+20 dBu=Maximum Input) -3dB, -6dB, -12dB and a signal present show the level below maximum input. In addition, the “Clip” lights function both as analog input “Clip” indicators and signal if there is clipping in the Digital Signal Path. If both A & B “Clip” LEDs flash yet a yellow -3 does not, this would indicate that the DSP is clipping and not the analog input circuitry. This situation would most likely be caused by excessive digital gain or EQ in one or more outputs.

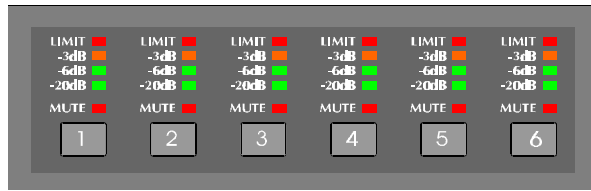

Figure 3 Output Bargraphs and Mute

4.2 LED Output Bargraphs: The output bargraphs 0dB headroom reference is shifted with respect to the limiter settings. In this way, each output can be set to reflect the specific level below maximum for the respective output. i.e. If a limiter is set to +8, then the “Limit” LED represents an output of +8dBu and the -3, -6 and -20dB LEDs refer to this level and signify +5, +2 and -12dBu, respectively. This relationship remains regardless of output gain settings as the limiters are the final element in the programming path. As an example, if a +4dBu signal is routed to an output and the gain is set to 0dB and the limiter is set to +10dBu, then the -6dB Led would light indicating 6 dB of headroom. (+10dBu - (4 + 0)dBu = 6dB)

4.3 Mute: Pressing any of the front panel **Mute** keys will toggle the respective channel in and out of mute. The LED will reflect the mute status. A Red LED on signifies the output is muted.

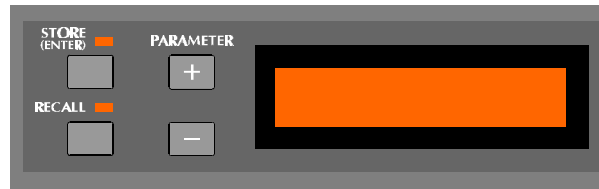

Figure 4 Store, Recall and Parameter Adjust

4.4 Store(Enter) and Recall: These keys allow the user to store and recall programs from the internal memories. The Store key is also used as an Enter Key to confirm certain operations such as a configuration change from 2 way to 3 way, MIDI Dump and OEM hiding which are explained further in Section 5.0 on Utility Control Parameters.

4.5 Plus and Minus: These keys adjust the currently selected parameter up or down. In the case of a non-numeric parameter, these keys scroll through a predefined set of variables.

4.6 LCD Display Screen: This 2 x 16 character LCD displays all required programming information. It is, in effect, a window into a large grid of adjustable parameters that moves from row to row and column to column. Figure 5 below as well as the back of this manual is a diagram of the programming grid. Upon turn on, the software revision will also appear briefly. The bottom line shows the program number and name of the stored program. An asterisk indicates that a program has been edited since the last store. This shown in the top right of the LCD display on all screens except the default.

The current program has been edited since the last Store command:

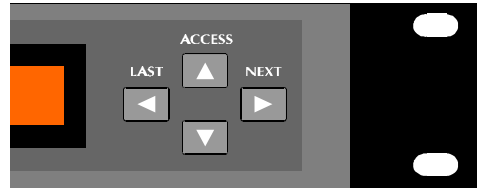
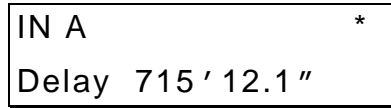

Figure 4 Access Buttons

4.7 Access Buttons: These four buttons step the display through input, output and system variables which are grouped in a grid as shown below in figure 5. All inputs and outputs are configured in rows with their respective parameters in columns. There are rows for Input A, Input B, Input Sum A+B, and Outputs 1 through Output 6. In addition, a row of Utility Control parameters is included. The **Up** and **Down** Access keys move the user between rows. The **Next** and **Last** keys step the user through the variables within the currently selected row. See section 9.0 on ASSIGNABLE EQ for the use of **Next** and **Last** to assign EQ to a channel.

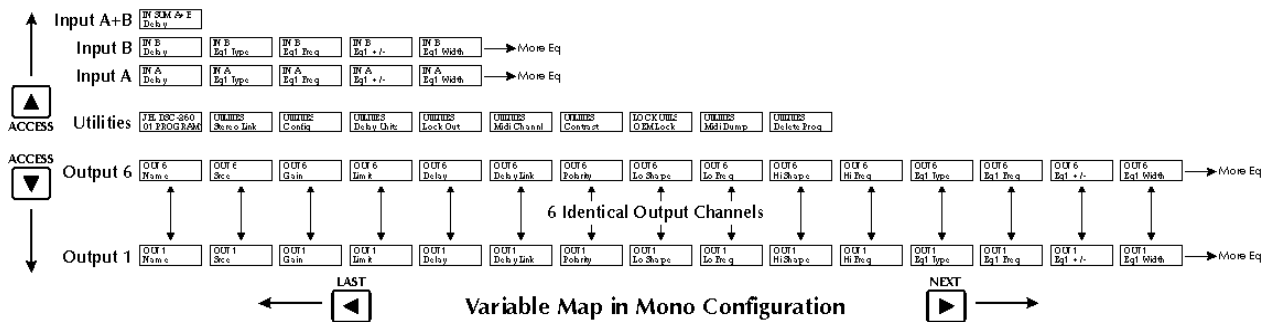

Figure 5 DSC260 Programming Grid

5.0 Utility Control Parameters

To access the Utilities Row use the **Up** or **Down** Access keys to scroll through the rows. Individual Utility parameters are reached by pressing **Next** and **Last** from the default screen.

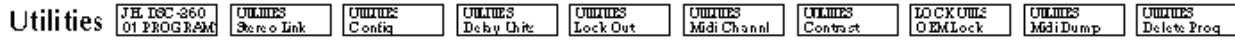
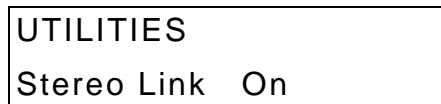

Figure 6 Utility Control Menu Options

5.1 Stereo Link This parameter adjusts the stereo linking of various outputs using the **Plus** and **Minus** keys to select between **Mono**, **2 channel x 3 way** and **3 channel x 2 way**. The linking works with the Configuration parameter located to the right of the Stereo Link parameter. In 2 channel x 3 way mode, output pairs 1 and 2, 3 and 4, 5 and 6 are linked. Typically the bass output would be output 1 and 2. In 3 channel x 2 way mode Outputs 1, 2 and 3 are typically low and 4, 5 and 6 are high. There are two different relationships between linked variables, step and offset. A Step Variable has discrete selections such as filter type, high pass slope, polarity, etc. If a Step Variable is changed e.g. high pass slope type, both channel values will be forced to the same value if linked. Those parameters that don't have discrete selections such as gain, frequency or delay can have offsets between them when the channels are linked. These are called "Offset Variables." If any linked variable reaches the variable's limit, none of the linked variables will be able to move further in that direction. Table 1 detail these relationships.

Link on and off:



Parameter	Linking Type	2 Channel 3 Way	3 Channel 2 Way
Input Delay	Offset Variable	A - B	A - B
Input EQ Type	Step Variable	A - B	A - B
Input EQ Frequency	Offset Variable	A - B	A - B
Input EQ +/-	Offset Variable	A - B	A - B
Output Name	Offset Variable	1 - 2	1-3
Output Source	Offset Variable	A - 1, 3 & 5, B-2, 4 & 6	A - 1& 4, B - 2 & 6, A+B - 3 & 5
Output Gain	Offset Variable	1 - 2, 3 - 4, 5 - 6	1 - 3, 4 - 6
Output Limit	Offset Variable	1 - 2, 3 - 4, 5 - 6	1 - 3, 4 - 6
Output Delay	Offset Variable	1 - 3, 3 - 5, 2 - 4, 4 - 6	1 - 4, 2 - 5, 3 - 6
Output Delay Link	N/A	1 - 3, 3 - 5, 2 - 4, 4 - 6	1 - 4, 2 - 5, 3 - 6
Polarity	Step Variable	1 - 2, 3 - 4, 5 - 6	1 - 3, 4 - 6
Output Lo Shape	Step Variable	1 - 2, 3 - 4, 5 - 6	1 - 3, 4 - 6
Output Lo Frequency	Offset Variable	1 - 2, 3 - 4, 5 - 6	1 - 3, 4 - 6
Output Hi Shape	Step Variable	1 - 2, 3 - 4, 5 - 6	1 - 3, 4 - 6
Output Hi Frequency	Offset Variable	1 - 2, 3 - 4, 5 - 6	1 - 3, 4 - 6
Output EQ Type	Step Variable	1 - 2, 3 - 4, 5 - 6	1 - 3, 4 - 6
Output EQ Frequency	Offset Variable	1 - 2, 3 - 4, 5 - 6	1 - 3, 4 - 6
Output EQ +/-	Offset Variable	1 - 2, 3 - 4, 5 - 6	1 - 3, 4 - 6
Eq Width	Offset Variable	1 - 2, 3 - 4, 5 - 6	1 - 3, 4 - 6

Table 1 Linked Parameter Relationships

5.2 Device Configuration, selectable Mono, 2 channel x 3 way, 3 channel x 2 way. Changing this mode changes the overall routing and linking of the unit. If the user changes this value, the user will have to confirm the selection as routing, linking, delay linking and band name data will be changed. The unit will also mute to ensure that the user can check that the outputs have appropriate bandwidth settings before continuing. The user can then move to the Output variables and change the routing, delay linking and band names as required. Figure 7 shows the two standard configurations.

Switching to 2 channel x 3 way configuration will force Outputs 1,3 and 5 to be routed from Input A and Outputs 2, 4 and 6 to be routed from Input B. All delay linking will be switched off and Stereo Link will be switched on. Band Names will be forced to 'Low', 'Mid', 'High', 'Low', 'Mid', 'High' for outputs 1 - 6 respectively. When only 2 way systems are used in stereo, outputs 3-6 are used for Low (3-4) and High (5-6). This allows subwoofers to be added on outputs 1 and 2 without rewiring existing systems.

When using a derived center cluster feed such as in L, C, R, the configuration can be changed to a 3 channel 2-way configuration where the center channel is a sum of A and B. This 3 channel x 2-way configuration will force Outputs 1 and 4 to be routed from Input A and Outputs 3 and 6 to be routed from Input B. Outputs 2 and 5 will be routed from Input A+B. All delay linking will be switched off and Stereo Link will be switched on. Band Names will be forced to 'Low' and 'High'.

Switching to Mono configuration will force all Outputs to be routed from Input A. Delay linking will be switched off and Stereo Linking will be switched off. Band Names will be forced to 'Band 1' through 'Band 6'.

Configuration:

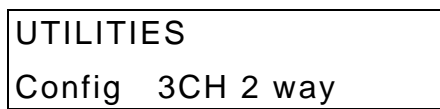

To change configurations press the **Plus** and **Minus** parameter keys to select the desired configuration, mono, 3-way or 2-way. This will call up the dialogue box below that will give you the question "Change to Mono?, 2-way or 3-way."

Change configuration?:

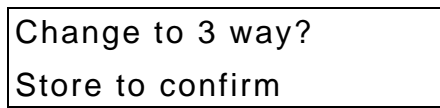

Pressing store will reconfigure the DSC260 to the desired set-up. **Pressing any of the access keys will cancel the operation and return you to the previous configuration.**

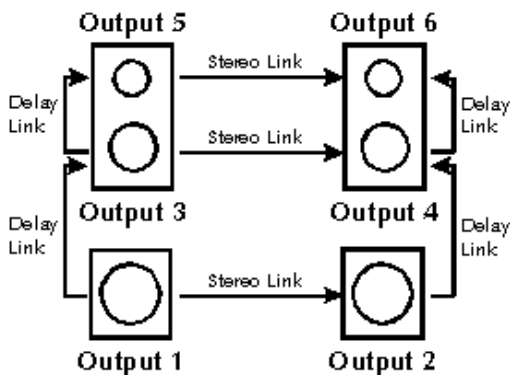

2 Channel 3 Way Configuration

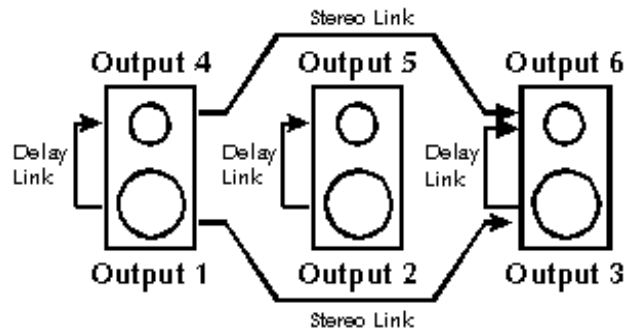

3 Channel 2 Way Configuration

Figure 7 Linking Relationships

5.3 Delay Units, selectable ms, ft and m: The delay units can be selected for the specific application in milliseconds, feet or meters. Use Parameter **Plus** and **Minus** keys to select the preferred measurement units. Moving to a different position on the grid will automatically store this parameter and recalculate the delay values for all displays.

Delay units:

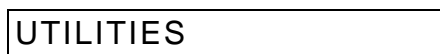

Delay Units ms

5.4 Lock Out selectable On or Off. With Lock Out ON no displayed variables (except Lock Out) can be adjusted. Mutes can still be adjusted. With Lock Out ON, no programs can be stored or recalled. For more information on other lock systems, see section 10 - Security.

Lock Out:

UTILITIES
Lock Out Off

5.5 Midi Channel Number; 1 to 16. Midi is used to transmit sysex dump data between units and transmit and receive program change. Use the **Plus** and **Minus** keys to adjust the channel number.

Midi channel number:

UTILITIES
Midi Channel 15

5.6 Contrast: The +/- Parameter keys increase/decrease the LCD display contrast. A graphical indication of the variable changing is displayed.

Contrast:

UTILITIES
Contrast /

5.7 OEM Lock. Pressing the **Plus** button will take the user into the OEM Lock password screen. See section 10 for more information on this function.

OEM Lock:

LOCK UTILITIES
OEM Lock Off

5.8 Midi Dump. This utility is used to dump program information between DSC260 units as well as to any MIDI Sysex capable sequencer or computer. Attach a MIDI cable from the MIDI Out of the sending unit to the MIDI In of the receiving unit.

Sending Unit Midi Dump Screen:

UTILITIES
Midi Dump No

Pressing the **Plus** parameter key on the sending unit will bring up a "MIDI Dump Yes" message with "Store to Confirm?"

Sending Unit Midi Dump screen

Midi Dump?
Store to confirm

At this time a Midi sysex message is sent out that prompts a DSC260 receiving unit that an incoming Midi dump will occur and the receiving unit will display the message below.

Receiving Unit Screen after MIDI Dump Prompt:

Incoming Dump
Allow Dump? Yes

If you do not want the receiving unit to overwrite the memories, press the **Minus** key on the receiving unit to change the Allow Dump message to "No." If this occurs, then the receiving unit will return to its normal operation and ignore any incoming program information.

Pressing **Access** Up or Down at any time will return the sending unit to the Utility list.

Pressing **Store/Enter** on the sending unit performs the dump. The screen displays a percentage of the dump performed. See Appendix C on MIDI Sysex for additional information.

Midi Dump screen

Midi Dump
50%

5.8 Program Delete. The **Plus** key enters the program delete screen.

Program delete?:

UTILITIES
Delete Prog No

Select the program using the **Plus** and **Minus** Keys.

DELETE
31 4892-90 @

Delete Program?
Store to confirm

5.8.1 The **Plus/Minus** keys select the program to Delete.

5.8.2 Pressing **Access** at any time will return to the Default screen.

5.8.3 Pressing **Store/Enter** a second time will delete the program.

6.0 Input Sections

On the DSC-260 there are three input sections; Input A, Input B and Input Sum A+B. When Inputs are linked in the Utility section both Input A and Input B variables are ganged. The sum variables are not ganged with A or B. The input sum of A+B only has a Delay value to edit. All EQ is done on the individual unmixed inputs and then summed into Input A+B.

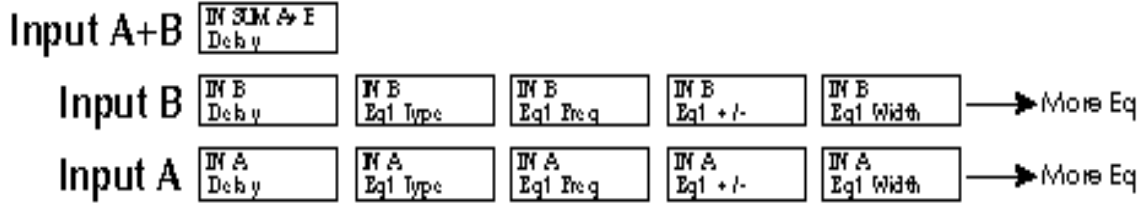

Figure 8 Input Parameters

Input A delay when in mono mode:

IN A Delay 630.000ms

Input A+B Sum delay:

IN SUM A+B Delay 0.000ms

Inputs A and B stereo linked: (Note the ampersand in place of the A + B to indicate stereo linked.)

IN A & IN B Delay 630.000ms

6.1 Input Delay: There is a main delay 0 - 635ms with 21 μ s increments for Input A, Input B and Input A+B. The **Plus/Minus** buttons accelerate in their effect the longer the buttons are held by increasing the size of the steps. To return to the small increment settings release the key then press again to begin with 21 μ s steps again. Delay units are set in the Utility section. At no time can there be more than 635.417 ms of delay on any input to output path.

Input A delay in feet and ins:

IN A Delay 715' 2.9"

Input A delay in meters:

IN A Delay 218.005m

6.2 Input EQ: Input A and B can have EQ assigned. High and low shelving with 12dB or 6dB/octave slopes as well as full parametric band are available. See Section 9.0 on Assignable EQ for more information. Input A+B is a sum of inputs A and B after any Input EQ.

7.0 Output Section Name, Source, Delay and Polarity

On the DSC260 there are six output sections; Output 1 through Output 6. When the unit is stereo linked in the Utility Menu, various outputs are linked so that when changing variables such as EQ or Crossover, both channels operate together. In 2 channel x 3 way configuration, output 1 and 2 variables, output 3 and 4 variables and output 5 and 6 variables are ganged in

pairs. In 3 Channel x 2 way configuration outputs 1, 3 and 5 outputs are linked as are 2, 4 and 6. When outputs are linked, the band name is derived from the channel assigned to the lower numbered output. Similarly, if the linked outputs are offset, the parameter value for the lower numbered output is displayed. From the Output parameter rows the **Next** and **Last** keys step through the output parameters.

7.1 Name: The Output 'band' name is selectable from a pre-programmed list. Use the **Plus** and **Minus** parameter keys scroll through this list.

Output 5 name:

OUT 5
Name High

7.2 Input Source: The combinations are as follows: Input A, Input B or a sum of Inputs A and B denoted as Input A + B. When Stereo Linked in 2 channel x 3 way mode, the selections are normally Inputs A & B. Notice the "&" in place of the "+" sign to denote A and B, not A plus B which signifies a sum of the two inputs.

Output 1 source:

OUT 1 Subs
Source IN A

Stereo Linked Output 1 & 2 source:

OUT 1 & 2 Subs
Source IN A & B

7.3 Output Gain: -25dB to +4 dB in 0.5dB steps. The nominal setting for outputs is -10dBu. The DSC is set-up to operate normally with a -10dB attenuation of the input signal to the least sensitive band. This has been designed to minimize the noise floor for those operators that keep their amplifier gain controls at maximum.

Output 1 gain:

OUT 1 Subs
Gain -15.0dB

7.4 Limiter threshold: -20 to +10dBu. This value is also the output meter reference value. If the Limiter is adjusted to 2.0 dBu as below, then the output 1 meter will represent +2dBu at limit with the -3, -6 and -20 dB reading relative to that level. i.e. -1dBu, -4dBu and -18dBu.

Output 1 limiter threshold:

OUT 1 Subs
Limit 2.0dBu

7.4.1 Limiter Level Calculations: The DSC260 comes from the factory with suggested limiter settings for various JBL systems. These limiter settings are guidelines for use with specific JBL power amplifiers. There are two primary uses for these limiters: One is for prevention of amplifier clipping and the second is to limit the amount of power transmitted to the transducers. When using JBL MPA and MPX power amplifiers consult the tables in Appendix B for recommended settings for specific amplifiers and power levels. For other amplifiers or transducers, the method for setting the limiting threshold is given by the following equation:

$$\text{Limiting Threshold (dB)} = \text{Transducer voltage limit (dBu)} - \text{Amplifier gain (dB)}$$

As an example, we first convert a transducer power rating into dBu. Our example transducers has a continuous power rating of 600 watts. With an impedance of 8 ohms, this corresponds to a voltage of:

$$\text{Voltage} = (600 \times 8)^{0.5} = 69.28 \text{ Volts}$$

Expressing this in dBu:

$$20 \log (69.28/0.775) = 39.03 \text{ dBu}$$

Next you find the amplifier gain from the published specification in the spec sheet or owner's manual. For this example, we will use an MPA1100 amplifier which has 38dB of gain and use the formula:

$$\text{Limiting threshold} = 39\text{dBu} - 38\text{dB} = 1\text{dBu}$$

This would be the limiter threshold for 600 watts continuous output into the 8 ohm transducer.

7.5 Variable Output Delay 0 - 635ms: The **Plus** and **Minus** buttons accelerate in their effect the longer the buttons are held by increasing the size of the steps. To return to the small increment settings release the key then press again to begin with 21 μ s steps again. At no time can there be more than 635.417 ms of delay on any input to output path. Delay units are set in the Utility section from a list of Milliseconds, Meters and Feet/Inches using the parameter keys in the Utility "Delay Units" section. These are displayed as ms, m and ft, respectively.

Output 1 delay:

OUT 1 Subs
Delay 600.000ms

Outputs 2 and 3 stereo linked:

OUT 3&4 Mid
Delay 600.000ms

Output 1 delay in feet and inches:

OUT 1 Subs
Delay 11' 12.9"

Output 1 delay in meters:

OUT 1 Subs
Delay 3.433m

7.5 Delay Linking: This is used to maintain offsets between various channels. Typical uses include setting individual transducer delay offsets for optimum performance and then linking them. If either linked channel's delay is changed, the linked channel(s) will follow and maintain the offset. Normally, the transducer delays are set, then any overall delay for cluster alignment or delay tower set-up. The following table shows the linkable channels in each mode.

Output	Mono	2channel x 3 way	3 channel x 2 way
1	2	3	4
2	3	4	5
3	4	5	6
4	5	6	None
5	6	None	None
6	None	None	None

Table 2 Delay Linking Relationships

Delay Linking:

OUT 1 Subs Delay Link Off

OUT 1 Subs Delay Link to 2

7.6 Switchable Polarity - Normal or Inverted. Using the **Plus** and **Minus** keys, the user can invert the polarity of the output signal. If the polarity is changed on a linked output, both outputs will change to the same selection.

Output 1 polarity normal:

OUT 1 Subs Polarity Normal

Output 1 polarity inverted:

OUT 1 Subs Polarity Invert

8.0 Output Crossover Slopes and Frequencies

The DSC260 allows full control over each high pass and low pass filter of a crossover segment in shape, slope and frequency. Graphically these parameters are labeled as in Figure 8 below.

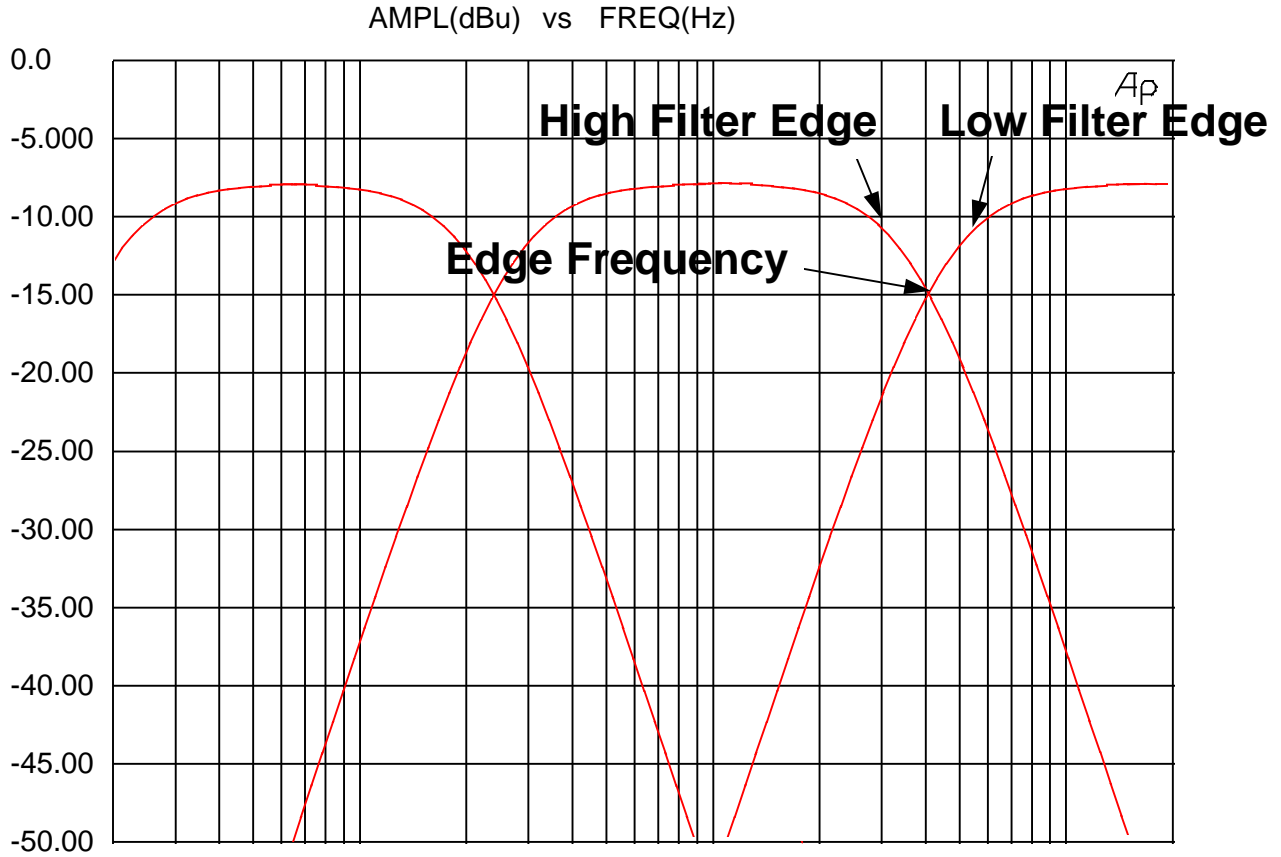

Figure 9 Filter Edge Identification

8.1 Low edge filter type: Using the **Plus** and **Minus** Keys, the Low edge filter type can be selected as Butterworth 12, 18, 24 or 48dB/Octave or Linkwitz-Riley 12, 24 and 48dB/Octave. The options are displayed as: BUT 12, L-R 12, BUT 18, BUT 24, L-R 24, BUT 48, L-R 48. The screen below show a low edge shape of Butterworth 12dB/Octave on output 5 which is labeled High. The various filter shapes are shown in Figures 11 and 12.

Output 5 low edge type:

OUT 5 High Lo Shape But 12

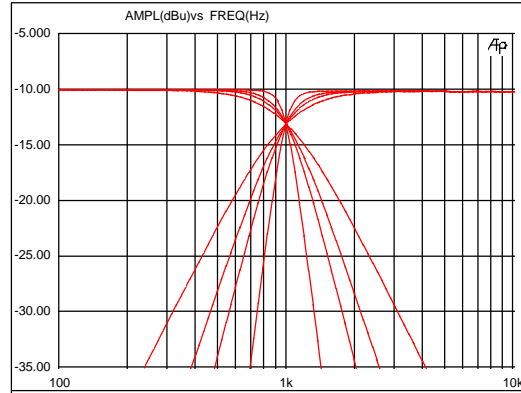
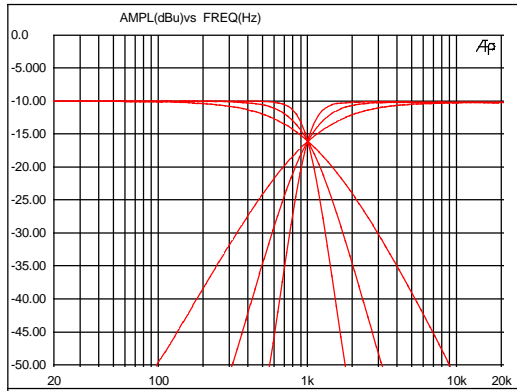

Figure 10 Linkwitz-Riley 12, 24 and 48dB/Octave Slopes Figure 11 Butterworth 12, 18, 24 and 48dB/Octave Slopes

8.2 Low edge filter frequency: This control adjusts the cut off frequency of the selected Low Frequency Crossover. The range is from 15Hz to 16kHz in approximately 1/6 Octave steps with “Out” at the bottom end and “Off” when adjusted beyond 16kHz.

Output 3 low edge frequency:

OUT 3 Lo/Mid
Lo Freq 220Hz

Note: If the Low edge filter frequency is raised beyond 16kHz, the channel output will be switched off. This is different from “Mute” in that any signal assigned to this output will not indicate on the output meters. Output meter deflection on unused outputs might confuse an operator.

8.3 High edge filter type: As with the Low edge filter frequency there are selections for Butterworth 12, 18, 24 or 48dB/Octave or Linkwitz-Riley 12, 24 and 48dB/Octave. The various filter slopes are shown in Figures 10 and 11.

Output 3 high edge type:

OUT 3 Mid
Hi Shape L-R 48

8.4 High edge filter frequency: This control adjust the cut off frequency of the selected High Frequency Crossover. The range is from 15Hz to 16kHz in approximately 1/6 Octave steps with “Out” beyond 16kHz.

Output 3 high edge frequency:

OUT 3 Mid
Hi Freq 2.0kHz

9.0 Assignable EQ

EQ is found at the end of the each channel's parameter adjustments. Pressing **Next** will step through the EQs assigned to the current input or output in the order: EQ type, EQ Frequency, EQ Cut/Boost amplitude and then EQ Width for "Bell" type filters.

If there is no EQ on the currently selected channel and there is a filter available, the **Next** button will step into an unused Bell EQ with 1kHz frequency, 0dB cut/boost and width of 0.3. The EQ type screen also shows the number of spare EQs. The EQ variable screen also shows the EQ number in the current channel. The letter M or S denotes whether the EQ was assigned when the unit was linked (Stereo) or unlinked (Mono).

9.1 EQ Type, selectable Lo6, Lo12, Bell, Hi6, or Hi12. The Sp value represents the number of filters available to the current channel. (In this case eight spare EQs are available. This value may be different for different channels depending on the power available in each DSP. (See Section 11 on Techniques, Tricks and Traps). This screen shows that this is the first EQ on output 5 which has been labeled High. It has a shape of Low Shelf at 12dB/Octave and there are eight spare EQs.

EQ type on Eq1 on Output 5

OUT 5 High
Eq1M Lo12 Sp 8

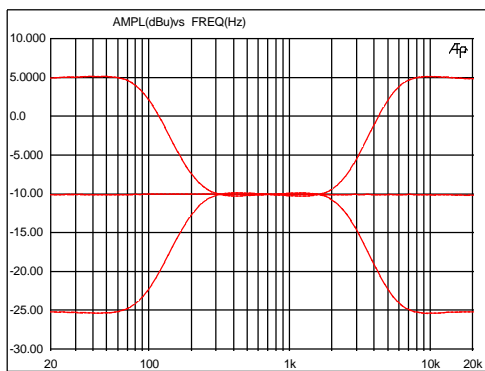

Figure 12 12dB/Octave Shelving EQ examples

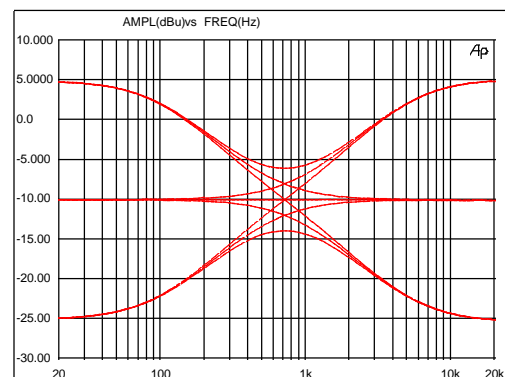

Figure 13 6dB/Octave Shelving EQ examples

9.2 EQ Frequency 15Hz to 16kHz The Frequency of the EQ is adjustable in approximately 1/6 Octave steps. The screen below shows that this is the first EQ on output 5 which is labeled High. It has a Frequency of 220.0 Hz. (Since it is a Low Shelving filter this is the - 3dB point.)

EQ freq on Output 5

OUT 5 High
Eq1M Frq 220.0Hz

9.3 EQ Cut/Boost -15 to +15dB in 0.5dB steps. Setting an EQ cut/boost to 0dB effectively de-assigns the filter, allowing it to be assigned to another channel.

EQ cut/boost on Output 5

OUT 5 High
Eq1M +/- -15.0dB

9.4 EQ Bandwidth 0.05 to 3.00 Octaves in 0.05 Octave steps. Width is only available for Bell type EQs. The limits of the width are shown in Figure 14.

EQ width on Output 6

OUT 6 High
Eq1M Wid 0.30Oct

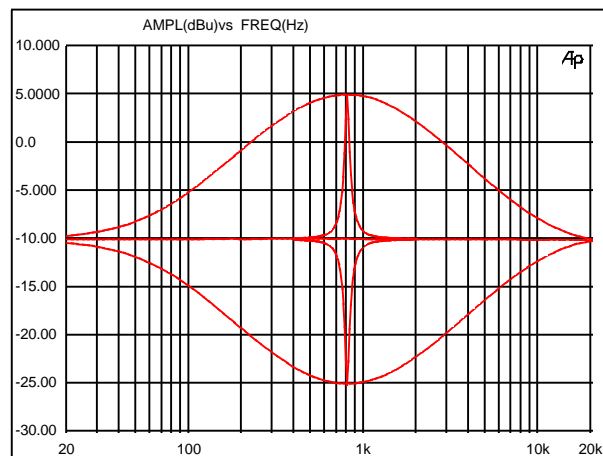

Figure 14 Limits of EQ Width

9.5 More than you probably want to know about filter/EQ assignment: The crossovers and EQs share DSP resources and there are 2 filter resource 'buckets' (one in each 56004 DSP chip.) All of the filters for EQs and crossovers come from these resources and have certain constraints that are followed in assignment. The table below summarizes how the resources are allocated.

DSP #	Total Filters	Output 1& 2 Crossovers	Output 3-6 Crossovers	Input EQ	Output 1&2 EQ	Outputs 3-6 EQ*
DSP1	18	All	None	All	All	Second
DSP2	20	None	All	None	None	First

* The EQ for outputs 3-6 may come from either DSP 1 or DSP 2, but DSP 2 filters are used first (unless all DSP 2 resources are allocated.)

- There are 18 filters in DSP 1, and 20 in DSP 2.
- All of the crossover filters for outputs 1 & 2 comes from DSP 1.
- All of the crossover filters for outputs 3-6 come from DSP 2.
- All of the Input EQ comes from DSP 1.
- All of the Output EQ for outputs 1 & 2 come from DSP 1.
- 12dB/Octave and 24dB/Octave crossovers use 2 filters per edge.
- 48dB/Octave crossovers use 4 filters per edge.

A Stereo 3-way 12dB/octave crossover is as follows:

- 4 filters are used in DSP 1 for output 1 & 2 crossover high edge crossovers. (2 per 12dB/Octave Slope)
- 12 filters used in DSP 2 for output 3-6 crossovers. (1 per 12dB/Octave Slope)
- There is a total of $(18-4)= 14$ filters left in DSP 1 for either Input EQ or Outputs 1 & 2 EQ.
- There is a total of $(20-12)= 8$ filters left in DSP 2 for output EQ any output.

10.0 Store, Recall and Security

Pressing **Store/Enter** will enter the Store screen with the last used program on the screen. Pressing **Access** at any time will return to the Default screen. Pressing **Store/Enter** will perform the Store if the program location is not locked.

Store screen

<p>STORE? 21 FORUM</p>

10.1 Program Naming: The **Next** and **Last** allow the user to step through the character positions of the program name. The **Plus** and **Minus** keys adjust the individual character through numbers and the alphabet.

- 10.1.1 The cursor starts on the program number; **Plus** and **Minus** will adjust the program number from 1 to 60. The name and program locked character will follow giving the details of the selected program.
- 10.1.2 Pressing the **Next** access key will move the cursor into the program name to edit it. **Plus** and **Minus** will adjust the selected character.
- 10.1.3 Pressing **Next** after the last character will move the cursor onto the program locked character. The **Plus** and **Minus** keys will allow the user to adjust the locked character.

10.2 Program Storing: An internal store will fail if the lock key character is ON when **Store/Enter** is pressed. The PROGRAM LOCKED message will stay on the screen for 3 to 4 seconds or until the user presses another key. If the user changes the lock character to off with the **Minus** key then the **Store** will be successful. Alternatively, the user can press Access to return to the Default screen.

Store has failed because program is locked.

<p>PROGRAM LOCKED! 21 FORUM @</p>

10.3 Program Locking: After Storing the program to memory, the user needs to select whether the program is stored locked. This can be done by leaving the screen displayed with the cursor on the lock character. The character would default to On (programs default to stored locked). The user may either press the **Access** to return to the default screen with the program locked or press **Store/Enter** a third time after changing the lower line to Unlocked with the **Plus** and **Minus** keys. The Store Unlocked? message will stay on the screen until a key is pressed. The **Plus** and **Minus** keys will change the Locked/Unlocked text.

Request lock or unlocked.

<p>Store Unlocked? Locked @</p>

10.4 Program Recall: Pressing **Recall** will enter the Recall screen with the last used program on the screen.

Recall screen (The key indicates that the program is locked)

<p>RECALL 31 MADISON @</p>

- 10.4.1 The **Plus** and **Minus** keys select the program to Recall.
- 10.4.2 Pressing **Access** at any time will return to the Default screen.
- 10.4.3 Pressing **Recall** a second time will recall the program.

10.5 Security Settings: There are two levels of security for the unit. These are used to protect the parameters or programs from being inadvertently changed by unqualified users.

- 10.5.1 **Lock Out in the Utilities area.** With lock out ON, no variables can be adjusted except Lock Out and no programs can be stored or recalled. This is the most basic security. Unless you know specifically to unlock the unit in the Utilities page, the unit will remain free from prying hands.
- 10.5.2 **OEM Lock in the Utilities area.** OEM lock allows the user to lock any or all of the variables in a single program from being *seen or adjusted*. These locks are stored with the program and are transferred as files are stored and recalled.

OEM lock screen.



- 10.5.3 Pressing **Plus** from the Utility screen enters the OEM password screen. The user enters a password by using the **Next** and **Last** keys to select the letters and the **Plus** and **Minus** keys to change the letters. Pressing **Store/Enter** enters the OEM Lock mode. As an example, a password of "KONA" is shown below. Note: The Factory default programs in locations 1, 2 and 3 come with no OEM password. These can be used to create your own OEM programs.

OEM Password screen.



- 10.5.4 Once in the OEM Lock set-up mode the user moves around the Input and Output screens as if selecting variables to adjust. The utility screens are not accessible in Lock set-up, nor are the Store and Recall screens.

In the Lock set-up mode, the unit is always unlinked i.e. variables have to be locked/unlocked individually, they cannot be locked in stereo pairs. The user can see the variable names and values if they are not locked. If the variable is unlocked, the current value is displayed. If the variable is locked the value is replaced with a key. The type of Lock Set-up - OEM - is indicated at the top right of the screen. The edited symbol is not displayed in the Lock set-up mode.

- 10.5.5 Variables are locked and unlocked with the **Plus** and **Minus** keys.

Polarity on Output 5 - OEM unlocked - selecting variables for OEM lock

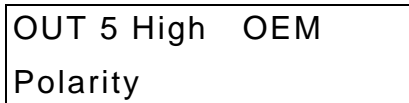

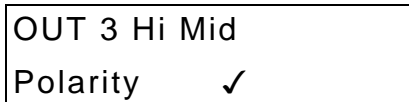

Polarity on Output 3 - OEM locked - User still in OEM Mode

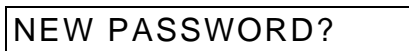

The Lock set-up process is finished with the **Store/Enter** key. The unit now comes back to the password screen with the *current* password on the screen. The user can change the password by using the **Next** and **Last** keys to select the letters and the **Plus** and **Minus** keys to change the letters. Below the password "KONA" has been changed to "KIZ." Pressing **Store/Enter** stores the new password and returns the user to the Utility menu.

OEM Password change screen.





KIZ_____

- 10.5.6 Once the user has left OEM mode, the unit will not display any OEM locked variables. If the user steps on to an OEM locked variable the display will jump to the next unlocked variable. If all variables in a channel are OEM locked the display will jump to the next channel.
- 10.5.7 If the unit is powered down while in OEM mode, the unit will return to OEM locked when the unit is turned back on with the current password still valid.
- 10.5.8 An OEM Locked program has a small padlock icon next to the program name when you scroll through using the **Store** and **Recall** Functions.



RECALL
31 MADISON 

Note: You cannot store a new program in an OEM locked location. You must delete the OEM locked program first using the Delete Program option in the Utility menu.

11.0 Techniques, Tricks and Traps

When developing a product such as the DSC260, you must balance how much flexibility is designed in versus the inevitable traps that might occur by having complete control over each outputs capability. The following section was designed to give the user a bit of a head start when delving deeper into programming the unit.

- 11.1 **Use Both Hands:** When programming the unit it might be helpful to use a two hand technique. Using the right hand for navigation around the programming grid and the left hand for adjusting the parameters. It helps remind the user that the right keys are for navigation and the left are for changing parameters.
- 11.2 **Oh, Where has my output gone?** If you have a signal source assigned to an output, but do not have any output, check that the Low Pass Filter Frequency parameter has not been set to "Off". If this has been adjusted upward beyond 16kHz, it will turn the output off.
- 11.3 **Delays in 1, 2, 3 Steps:** When using Delay Linking, it is recommended that the adjustment order is: 1. Transducer alignment within cabinets; 2. Cabinet alignment within Clusters; 3. Delay Alignment between Clusters. In 2 channel x 3 Way and 3 channel x 2 way, the default settings include delay linking as well as stereo linking. See section 5 for additional information.
- 11.4 **Why do both Input Clip LEDs light without a +20dBu input:** Situations can occur when both Input Clip LEDs light. If this occurs without full input signal, then this signifies a clip within the digital signal path. This normally occurs if excessive EQ boost or gain has been programmed into one or more outputs.
- 11.5 **I'm trying to adjust a crossover or EQ frequency but it won't go as high or as low as I want.** Check for any stereo linked parameters that might contain an offset. If there is an offset between a stereo linked variable and the linked variable is at its limit, then the parameter you are adjusting will not go any further. You can check this by turning Stereo Linking Off and looking at the parameters in question. As an example, you could have a stereo EQ variable that is linked with a 5kHz offset so that output 5 is at 10kHz and Output 6 is at 15kHz. If you try and adjust the EQ on output 5 upward, it will only go to 11kHz, not all the way to 16kHz. This is because as you adjust output 5 upward, output 6 also goes upward to a maximum of 16kHz.
- 11.6 **I can't get the delay to go to it's maximum of 635 ms.** As with example 11.5 above, linked parameters can cause confusion when they are linked with offsets. If a linked delay is at its maximum, trying to adjust another linked delay will stop at a value of 635ms minus the amount of the offset. As an example, you have a delay link between output 3 (100ms) and output 5 (200ms). If you try and adjust output 3 upward you will be able to get a maximum of 535ms. (635ms - 100ms = 535ms)
- 11.7 **I don't have any linked delays, but I can't get the maximum 630ms on an input or output.** The maximum delay is a combination of the amount of delay assigned at the input section plus the amount assigned at the output section. The maximum combined delay from input to output is 635 ms.
- 11.8 **"Warning, No More Filters"** Even with the flexibility and full feature set of the DSC260, you could run out of DSP power at some stage. While the engineers and designers of this product have tried to squeeze out every last bit of power, in some cases you might see the dreaded "Warning, No More Filters?" message. This indicates that there are no more filter sections available in the DSPs. This can occur when trying to add more EQ, adding a crossover slope or increasing a crossover slope. This message is most likely to occur when using 48dB/Octave slopes that eat up DSP power quickly. Check below for more information.
- 11.9 **The DSC260 has a Split Personality.** There are two DSPs in the DSC260. Crossover and EQ filter assignments are split between them. It is possible to use up all available EQ on the inputs and outputs 1 & 2 and still have EQ available on Outputs 3-6. For people who like clever number puzzles, section 9.5 details these guidelines. For the rest of us, there is almost always enough EQ to go around.

11.10 **Start with the Bass:** Because of the way DSP is allocated, it is recommended that the programming sequence is as follows:

Assignment Order	Parameters	Reasoning
1	Output Crossovers 1 & 2	Use these for Low Frequency Outputs. They generally need the least amount of EQ and lower order crossover slopes. All EQ for outputs 1 & 2 and Inputs comes from DSP 1 only. Using less power hungry crossover slopes typical of low frequency crossovers frees up EQ for Outputs 1 & 2 and inputs.

2	Output Crossovers 3-6	Use these for mid and high crossover outputs, because outputs 3-6 can use EQ power from both DSPs. These outputs are typically of higher slope and can require more EQ.
3	Output 1 & 2 EQ	As with the Output Crossovers, EQ on outputs 1 & 2 can only come from DSP 1.
4	Output 3-6	By getting the outputs of 3-6 EQ'ed correctly, there will be little need for Input EQ.
5	Input EQ	For touch up and taste with what's left. If there is no more Input EQ available, adjustment of individual band EQ must be used or EQ must be "de-assigned" from outputs 1-2 to free up EQ for the inputs. Freeing up EQ on outputs 3-6 will not free up resources for input EQ because the filters come from different DSPs.

Table 3 Filter Assignment Recommendations

11.11 I've done it your way but I need more EQ on Inputs or Outputs 1 & 2: If you have maxed out EQ on the Inputs and Outputs 1 & 2, but have spare filters in outputs 3-6, you need to get more power to the inputs. De-assign Output 1 & 2 EQ and put the power into Input EQ. After you have the Input EQ assigned, go back and assign your Output 1 & 2 EQ. This time, the Output 1 & 2 EQ will be taken from other resources.

12.0 Specifications

Inputs:	2 channels, Maximum level +20dBu, 10k \leq imp., Pin 2 + Electronically Balanced
Outputs:	6 channels, Maximum level +10dBu, into 600 \leq imp., Pin 2 + Electronically Balanced
Output Impedance:	47 \leq
Dynamic Range:	>100 dB
Frequency Response:	20Hz - 20kHz \pm 0.5dB
Total Harmonic Distortion:	<0.05%, 20 Hz - 20 kHz, @+10dBu
Configuration:	Stereo 2 way and 3 way, Mono 4, 5, 6 way, Any combination of 2 inputs to six outputs with individual passbands.
Crossover Slopes:	Butterworth 12, 18, 24 or 48dB/Octave and Linkwitz-Riley 12, 24 or 48dB/Octave.
Front Panel Controls:	Softkeys for programming functions. Mute on each output and LED level meters with limit, -3, -6 and -20dB below threshold. Input LED meters with signal present, -12, -6 and -3dB and Clip.
Display:	2 x 16 Character Backlit LCD
Limiters:	Mid Band Limiters with variable threshold of -10 to +10dBu
Power Requirements:	100 - 240 Volts 50/60 Hz \pm 10%
Sample Rate:	48 kHz
A/D Conversion:	
Assignable Equalization:	An array of up to 38 bands of EQ can be assigned to the inputs and outputs. Dependent upon slopes of crossovers used. High and Low shelving at 6dB or 12dB/Octave or fully parametric with a variable bandwidth of 0.05 to 3.0 octaves. Frequency range from 15Hz to 16kHz. Amplitude of \pm 15dB in 0.5 dB steps.
Assignable Delay:	Up to 635 ms of delay on each input to output path including Input A, Input B, Input A + B Sum and Outputs 1-6.
Latency:	1.2 ms, any input to any output.
Delay Resolution:	21 μ s steps
Memory:	60 User Programs stored in Flash Memory
Dimensions:	44.4mm x 483mm x 203mm HxWxD (1.75" x 19" x 8")
Net Weight:	2.8 kg (6.2 lbs)
Shipping Weight:	4.5 kg (9.9 lbs)
Safety Agency Approvals:	CE, ETL

Appendix A: Connector Wiring Information

Balanced wiring: Whether a system is wired to a 'pin 3 hot' convention is not so important so long as the wiring to both the input and output are the same. Input cable shield needs to be derived from the signal source end as pin 1 is ground lifted for the inputs. It is recommended that high quality audio cable with two conductors and a shield for low noise be used.

Unbalanced wiring: If the equipment driving the DSC260 has only unbalanced outputs then the input plug to the DSC260 should be wired so that the shield connection on pin 1 is shorted to EITHER pin 2 OR pin 3, depending on the wiring convention of the unbalanced equipment at the send end.

If the equipment connected to the DSC260 outputs has only unbalanced inputs, we recommend the use of balanced (i.e. 2-conductor shielded) cable. The interconnecting cable should have the shield grounded to pin 1 at the DSC260 output, the output "cold" should be connected to the unbalanced input 0 V ground, and the output "hot" should be connected to the unbalanced live input. There should be no connection between the cable screen and the 0 V/chassis ground connection of the unbalanced equipment. Strict adherence to this will help to eliminate potential ground loop hums by removing signal currents from the cable shield.

Following the wiring conventions noted above within a fully balanced signal system will yield the best possible results with none of the problems often associated with interconnected audio equipment. Wherever possible, the cable shield should not be connected to any signal pin, but rather left to perform a cable shielding function only.

Under no circumstances should safety ground wire be removed from the AC power connector as an interim measure to achieve similar results.

Avoiding ground loops: A typical example of a ground loop situation is shown in the diagram below. Two interconnected components of a system are grounded through their individual AC power ground connections to separate AC power outlets. In this situation a path to ground exists both directly through the mains earth of each component and also via the shield in the signal wire to the AC power ground connection of the other component. In effect the two paths to ground form a loop antenna which picks up interference currents from surrounding equipment. Because of lead resistance these induced currents are transformed into voltage fluctuations in the ground system and hence the reference ground is no longer at a stable potential.

Various connection configurations are possible to prevent ground loops occurring. The aim is always to ensure that a loop path is never actually formed. It can be seen from the diagram above that this could, in theory, be achieved by disconnecting the AC power ground connection, however this practice is totally unsafe and should never be implemented as it could produce a potentially lethal voltage at the case or accessible parts of the unit.

The most flexible solution, and easiest to implement in touring system, is to use the practice of telescoping shields. This method is highly effective in removing ground loops and prevents unwanted signals entering the signal chain as the shield is always connected to ground at only one point. The DSC260 is designed with the input ground connections isolated so that a ground loop will not occur between the DSC260 and the preceding source component as shown below.

Appendix B: Output Assignment Matrix for JBL Systems

System	Out 1	Out 2	Out 3	Out 4	Out 5	Out 6
2 Channel 2 Way Stereo	Unused	Unused	Low A	Low B	High A	High B
2 Channel 3 Way Stereo	Low A	Low B	Mid A	Mid B	High A	High B
Mono 6 Band	Full A	Full A	Full A	Full A	Full A	Full A
3 Channel 2 Way Config.	Low A	Low A+B	Low B	High A	High A +B	High B
4890, 4891, 4892, 4894, DMS-1	Unused	Unused	Low A	Low B	High A	High B
4892+Subs, 4894+Subs, S201, S202, S203, S204, S205, S206, S210	Subs A	Subs B	Low A	Low B	High A	High B
HLA 4895, AS32XX Stereo 3 Way	Lo/Mid A	Lo/Mid B	Hi/Mid A	Hi/Mid B	High A	High B
HLA Mono 4 Way, AS32XX 4 Way	Unused	Unused	Subs A	Lo/Mid A	Mid/MidA	High A
567X, 219X	Low A	Low B	Mid A	Mid B	High A	High B

1. Before making any connections between the controller and the amplifiers, make sure that all power to the amplifiers is disconnected and their level controls are completely down.
2. The DSC260 has been programmed for many popular JBL Speaker System models. Before connecting the controller to the amplifiers, this program should be changed to a setting that matches your JBL system.
3. This is done by powering on the DSC260 then pressing **RECALL**. Use the Parameter **Plus** and **Minus** buttons located on the left side of the LCD panel to page up and down until the correct setting is visible. Press **RECALL** after the cursor is on the setting.
4. Connect the console outputs to the inputs of the DSC260. Left to A and Right to B. In the case of a mono system, use input A.
5. Connect the outputs of the controller to the amplifier input channels maintaining the Left and Right identification. Typically the higher the number of the output, the higher the frequency content. i.e. In a 2 channel 3 way default, outputs 1 & 2 are Low, 3 & 4 are Mid and 5 & 6 are high. As the outputs vary depending upon the type of system and program loaded into the DSC260, consult Appendix B for correct output information.
6. Turn on the power to the console, controller(s) and finally the amplifiers. (It is best to turn the amplifiers on last and off first to prevent any thumps or pops from damaging the transducers.)
7. Apply a signal source to the controller. This can be pink noise, a tone or music.
8. Unmute the outputs on the DSC260, one at a time. The RED LEDs below each Output Meter signify the output is muted.
9. Advance each amplifier channel slowly and confirm that the signal reaching the transducers is correct. (It is best to begin with channels driving the low frequency transducers first. In this way, if the high and low are reversed, high frequency signals will be going to the woofer. It's better to find this problem then if the low frequencies were going to the high frequency device!)

After it is confirmed that all transducers are receiving the proper signals, initial calibration can begin.

Limiter Settings for Power Levels into 4 ohms per channel										
Power Amp	75 w	150 w	200 w	300 w	500 w	600 w	800 w	1200 w	2400 w	
MPA 275	-4 dBu	-1 dBu	0 dBu							
MPA 400	-6 dBu	-3 dBu	-2 dBu	0 dBu						
MPA 600	-8 dBu	-5 dBu	-4 dBu	-2 dBu	0 dBu	1 dBu				
MPA 750	-9 dBu	-6 dBu	-5 dBu	-3 dBu	-1 dBu	0 dBu				
MPA 1100	-11 dBu	-8 dBu	-7 dBu	-5 dBu	-3 dBu	-2 dBu	-1 dBu	1 dBu		
MPX 300	-4 dBu	-1 dBu	0 dBu	2 dBu						
MPX 600	-8 dBu	-5 dBu	-4 dBu	-2 dBu	0 dBu	1 dBu				
MPX 1200	-11 dBu	-8 dBu	-7 dBu	-5 dBu	-3 dBu	-2 dBu	-1 dBu	1 dBu		
Limiter Settings for Power Levels into 8 ohms per channel										
Power Amp	75 w	150 w	200 w	300 w	500 w	600 w	800 w	1200 w	2400 w	
MPA 275	-4 dBu	2 dBu								
MPA 400	-3 dBu	0 dBu	1 dBu							
MPA 600	-5 dBu	-2 dBu	-1 dBu	1 dBu						
MPA 750	-6 dBu	-3 dBu	-2 dBu	0 dBu	2 dBu					
MPA 1100	-8 dBu	-5 dBu	-4 dBu	-2 dBu	0 dBu	1 dBu	2 dBu			
MPX 300	-1 dBu	2 dBu								
MPX 600	-5 dBu	-2 dBu	-1 dBu	1 dBu	3 dBu					
MPX 1200	-8 dBu	-5 dBu	-4 dBu	-2 dBu	0 dBu	1 dBu	2 dBu			
Bridge Mode Limiter Settings for Power Levels into 8 ohms										
Power Amp	75 w	150 w	200 w	300 w	500 w	600 w	800 w	1200 w	2400 w	
MPA 275	-7 dBu	-4 dBu	-3 dBu	-1 dBu	1 dBu					
MPA 400	-9 dBu	-6 dBu	-5 dBu	-3 dBu	-1 dBu	0 dBu	1 dBu			
MPA 600	-11 dBu	-8 dBu	-7 dBu	-5 dBu	-3 dBu	-2 dBu	-1 dBu	1 dBu		
MPA 750	-12 dBu	-9 dBu	-8 dBu	-6 dBu	-4 dBu	-3 dBu	-2 dBu	0 dBu		
MPA 1100	-14 dBu	-11 dBu	-10 dBu	-8 dBu	-6 dBu	-5 dBu	-4 dBu	-2 dBu	1 dBu	
MPX 300	-7 dBu	-4 dBu	-3 dBu	-1 dBu	1 dBu	2 dBu				
MPX 600	-11 dBu	-8 dBu	-7 dBu	-5 dBu	-3 dBu	-2 dBu	-1 dBu	1 dBu		
MPX 1200	-14 dBu	-11 dBu	-10 dBu	-8 dBu	-6 dBu	-5 dBu	-4 dBu	-2 dBu	1 dBu	

Appendix C: Midi Implementation

FUNCTION	TRANSMITTED	RECOGNIZED	REMARKS
BASIC CHANNEL			
Default	1-16	1-16	Memorized
Changed	1-16	1-16	
MODE	X	X	
NOTE NUMBER	X	X	
VELOCITY	X	X	
AFTER TOUCH	X	X	
PITCH BENDER	X	X	
PROGRAM CHANGE	0-59	0-59	
True Number	1-60	1-60	
SYSTEM EXCLUSIVE			
Dump Request	X	O	
Dump Follows	O	O	
Program Request	X	O	
Program Follows	O	O	
SYSTEM COMMON	X	X	
SYSTEM REAL TIME	X	X	
AUX MESSAGES	X	X	

O: Yes X: No

DSC-260 Midi Sysex Format

The dump is sent as a series of system exclusive messages. The first message is a request to overwrite the memory of the DSC260.

Overwrite Memory Request

System exclusive status	F0H	Sysex Message Starts
Manufacturer ID	00H 20H 18H	
Basic Channel	nnH	0-15, or 7FH for all channels
Message Follows	06H	
Message -Request Overwrite	03H	
End of System Exclusive	F7H	

The second message is “Incoming dump, delete all programs?” If the Overwrite Memory Request is not accepted on the receiving unit, this message will be ignored. The DSC260 deletes all programs from 1 up to 60 at this point, if the plug is pulled after this message, you can't get them back!

Delete All Request

System exclusive status	F0H	Sysex Message Starts
Manufacturer ID	00H 20H 18H	
Basic Channel	nnH	0-15, or 7FH for all channels
Message Follows	06H	
Message -Delete all, dump follows	0FH	
End of System Exclusive	F7H	

The next message is the “system data” such as delay units, etc. Although the whole system structure is sent, only the delay units are implanted as all the rest are the user's choices, lock mode, midi channel etc. Bytes are sent with the low 4 bits (nybble) followed by the top nybble. So Hex 0x74 is sent as 0x04 followed by 0x07. All values that follow are hex unless otherwise stated. Multiple byte values are sent with the highest byte first and the bytes split low nybble then high nybble.

System Dump Request

System exclusive status	F0H	Sysex Message Starts
Manufacturer ID	00H 20H 18H	
Basic Channel	nnH	0-15, or 7FH for all channels
DSC260 System follows	1CH	
Size of message	03H	Number of bytes divided by 32.
Program Number	00H	Not used in this case.
Dump Data (96 bytes)	ddH	
End of System Exclusive	F7H	

Programs must be sent with the highest program numbers first. The DSC260 expects the last program to be program 0 (the 'current' program). This is the data that is actually in use at the time and may not have been stored in one of the 60 programs. Reception of the Delete All message (above) puts the unit into a 'sleep mode'. Reception of program 0 is the signal for the unit to return to normal speed. Sleep mode while a dump is coming in is to ensure that all bytes are handled and that the flash erasing and programming can get the full time of the processor. If program 0 is not received the unit's sleep mode will time out after about 20 seconds but during this period of the dump, the keys and display will not appear to be working. At the end of the time-out a message is displayed. If the unit is turned off during this time no data will be lost as data is written as each program is received.

A single program dump can be sent at any time but be aware that sending a large number of new programs in quick succession while the unit is running at normal speed may cause midi bytes to be lost as there is not enough buffer space for full speed midi data during the one or two seconds it takes to erase a flash page.

Program Dump Message

System exclusive status	F0H	Sysex Message Starts
Manufacturer ID	00H 20H 18H	
Basic Channel	nnH	0-15, or 7FH for all channels
DSC260 System follows	1CH	
Size of message	18H	Number of bytes divided by 32.
Program Number	ppH	
Dump Data (426 -778 bytes)	ddH	Pairs of 4-bit nybbles, LS first. Size dependent upon EQ assignments.
End of System Exclusive	F7H	

Appendix D: User Program Templates

Speaker System:

Date:

Parameter	Input A	Input B	Input A + B
Input Delay			
Input EQ1 Type			
Input EQ1 Frequency			
Input EQ1 +/-			
Input EQ1 Bandwidth			
Input EQ2 Type			
Input EQ2 Frequency			
Input EQ2 +/-			
Input EQ2 Bandwidth			
Input EQ3 Type			
Input EQ3 Frequency			
Input EQ3 +/-			
Input EQ3 Bandwidth			
Input EQ4 Type			
Input EQ4 Frequency			
Input EQ4 +/-			
Input EQ4 Bandwidth			

Parameter	Output 1	Output 2	Output 3	Output 4	Output 5	Output 6
Output Name						
Output Source						
Output Gain						
Output Limit						
Output Delay						
Output Delay Link						
Polarity						
Output Lo Shape						
Output Lo Frequency						
Output Hi Shape						
Output Hi Frequency						
Output EQ1 Type						
Output EQ1 Frequency						
Output EQ1 +/-						
Output EQ1 Bandwidth						
Output EQ2 Type						
Output EQ2 Frequency						
Output EQ2 +/-						
Output EQ2 Bandwidth						
Output EQ3 Type						
Output EQ3 Frequency						
Output EQ3 +/-						
Output EQ3 Bandwidth						
Output EQ4 Type						
Output EQ4 Frequency						
Output EQ4 +/-						
Output EQ4 Bandwidth						

Speaker System:

Date:

Parameter	Input A	Input B	Input A + B
Input Delay			
Input EQ1 Type			
Input EQ1 Frequency			
Input EQ1 +/-			
Input EQ1 Bandwidth			
Input EQ2 Type			
Input EQ2 Frequency			
Input EQ2 +/-			
Input EQ2 Bandwidth			
Input EQ3 Type			
Input EQ3 Frequency			
Input EQ3 +/-			
Input EQ3 Bandwidth			
Input EQ4 Type			
Input EQ4 Frequency			
Input EQ4 +/-			
Input EQ4 Bandwidth			

Parameter	Output 1	Output 2	Output 3	Output 4	Output 5	Output 6
Output Name						
Output Source						
Output Gain						
Output Limit						
Output Delay						
Output Delay Link						
Polarity						
Output Lo Shape						
Output Lo Frequency						
Output Hi Shape						
Output Hi Frequency						
Output EQ1 Type						
Output EQ1 Frequency						
Output EQ1 +/-						
Output EQ1 Bandwidth						
Output EQ2 Type						
Output EQ2 Frequency						
Output EQ2 +/-						
Output EQ2 Bandwidth						
Output EQ3 Type						
Output EQ3 Frequency						
Output EQ3 +/-						
Output EQ3 Bandwidth						
Output EQ4 Type						
Output EQ4 Frequency						
Output EQ4 +/-						
Output EQ4 Bandwidth						

Speaker System:

Date:

Parameter	Input A	Input B	Input A + B
Input Delay			
Input EQ1 Type			
Input EQ1 Frequency			
Input EQ1 +/-			
Input EQ1 Bandwidth			
Input EQ2 Type			
Input EQ2 Frequency			
Input EQ2 +/-			
Input EQ2 Bandwidth			
Input EQ3 Type			
Input EQ3 Frequency			
Input EQ3 +/-			
Input EQ3 Bandwidth			
Input EQ4 Type			
Input EQ4 Frequency			
Input EQ4 +/-			
Input EQ4 Bandwidth			

Parameter	Output 1	Output 2	Output 3	Output 4	Output 5	Output 6
Output Name						
Output Source						
Output Gain						
Output Limit						
Output Delay						
Output Delay Link						
Polarity						
Output Lo Shape						
Output Lo Frequency						
Output Hi Shape						
Output Hi Frequency						
Output EQ1 Type						
Output EQ1 Frequency						
Output EQ1 +/-						
Output EQ1 Bandwidth						
Output EQ2 Type						
Output EQ2 Frequency						
Output EQ2 +/-						
Output EQ2 Bandwidth						
Output EQ3 Type						
Output EQ3 Frequency						
Output EQ3 +/-						
Output EQ3 Bandwidth						
Output EQ4 Type						
Output EQ4 Frequency						
Output EQ4 +/-						
Output EQ4 Bandwidth						

